



# MILLWORK CATALOG

---

WINDOWS

2024 EDITION



# TABLE OF CONTENTS

## PELLA®

### RESERVE™

WOOD & ALUMINUM CLAD WOOD FAMILIES ....	6
TRADITIONAL - WOOD & ALUMINUM CLAD WOOD ....	8
CONTEMPORARY - ALUMINUM-CLAD WOOD ...	10
FEATURES & OPTIONS .....	12

### LIFESTYLE SERIES

ALUMINUM-CLAD WOOD WINDOWS .....	16
FEATURES & OPTIONS .....	18

### IMPERVIA®

FIBERGLASS WINDOWS .....	22
FEATURES & OPTIONS .....	24

### 250 SERIES

VINYL WINDOWS .....	28
---------------------	----

### ENCOMPASS

VINYL WINDOWS .....	30
---------------------	----

### 250 SERIES & ENCOMPASS

FEATURES & OPTIONS .....	32
--------------------------	----

### PELLA®

WINDOW & PATIO DOOR LINES .....	36
WINDOW & DOOR TRIM OPTIONS .....	38
STEADY SET™ .....	40

## MI® WINDOWS AND DOORS

### MI® WINDOWS AND DOORS

V2000 VINYL MODELS 1255 + 3500 .....	44
V2000 VINYL MODEL 3540 .....	46
V2000 VINYL MODEL 1555 .....	48
V3000 VINYL MODEL 1620 .....	50
V3000 VINYL MODEL 1556 .....	52
V3000 VINYL MODELS 1675 + 9770 .....	54
V3000 VINYL GARDEN WINDOW .....	56

## ATRIUM®

### ATRIUM®

5700 VINYL SERIES .....	60
5700 VINYL SLIDER .....	61
130 VINYL SERIES .....	62
150 VINYL SERIES .....	63
450 VINYL SERIES .....	64
750 VINYL SERIES .....	65
VINYL ARCHITECTURAL SHAPES .....	66
SIMULATED DIVIDED LITE .....	70
BRONZE LAMINATE .....	71
BLACK PAINT .....	72

## KRESTMARK®

### KRESTMARK®

200-275 VINYL SERIES .....	76
250 VINYL SERIES .....	78
400 VINYL SERIES .....	80
220 VINYL REPLACEMENT .....	82

## PLYGEM®

### PLYGEM®

1100 VINYL SERIES .....	86
4800 THERMAL BREAK ALUMINUM .....	88

## BURRIS WINDOWS

### BURRIS WINDOWS

TECTVIEW EX VINYL .....	92
TECTVIEW AC VINYL .....	93
TECTVIEW CA VINYL .....	94

### WINDOR WINDOWS

2750 FOLDING WINDOW .....	96
---------------------------	----

## SIMONTON® WINDOWS AND DOORS

### SIMONTON® WINDOWS AND DOORS

PREMIUM VINYL COASTAL WINDOWS .....	100
PREMIUM VINYL SUNROOM WINDOWS .....	104

## VELUX®

### VELUX®

SOLAR POWERED FRESH AIR SKYLIGHT .....	108
ELECTRIC FRESH AIR SKYLIGHT .....	110
MANUAL FRESH AIR SKYLIGHT .....	112
FIXED SKYLIGHT .....	114
TOUCH REMOTE CONTROLS .....	116
THREE LAYERS OF WATER PROTECTION .....	118
COMPLETE LIGHT CONTROL .....	119
QPF SELF-FLASHED FIXED SKYLIGHT .....	120
FX DOUBLE DOME SKYLIGHT .....	122
QX DOUBLE DOME SKYLIGHT .....	123











## Pella® Reserve™

Authentic designs with uncompromised attention to detail.

Made for the distinction creators, the purists of design, the architectural historians — each window and door is meticulously designed to achieve your vision. We deliver tailor-made solutions and intentional innovations to achieve your unique vision without concessions. From simple yet sophisticated style to historical detailing, anything less simply won't do.



Pella Reserve — Traditional windows and patio doors are exquisitely designed with unparalleled historical detailing. They feature through-stile construction, deliberate proportions and intricate profiles to achieve authentic traditional style.





# PELLA® RESERVE™

## WOOD & ALUMINUM CLAD WOOD FAMILIES



Contemporary-designed Pella Reserve windows and patio doors offer simple and sophisticated styles with expansive glass, sleek, minimal profiles and through-stile construction, which embody the tenets of pure contemporary design.



### Pella® Reserve™ Traditional

Wood & Aluminum-Clad Wood

#### Unparalleled historical detailing

Featuring historic elements with uncompromised attention to detail, including Integral Light Technology® grilles and a historic putty profile.

#### Authentic hardware

With a historically authentic spoon-lock and our Antiek casement window hardware inspired by period furniture.

#### Integrated Rolscreen®

A retractable screen that appears when you open the window and disappears into the frame when the window is closed.



Exquisitely designed windows and doors with unparalleled historical detailing. Featuring through-stile construction, deliberate proportions and intricate profiles to achieve authentic traditional style. Durable interiors and extruded aluminum exteriors allow you to create the ideal look for your design. And with cutting-edge innovations that solve modern-day inconveniences without compromising the design, your clients can be proud to own Pella Reserve – Traditional windows and patio doors. We know your reputation matters, so we stand behind Pella Reserve products with the best limited lifetime warranty for wood windows and patio doors.\*

Achieve your vision and impress your clients. From preliminary drawings to installation, Pella's expert team of architects, engineers, drafters and consultants can work to deliver custom window and door solutions for your project. Partner with Pella to achieve your unique vision without concessions. And with large multi-slide and bifold patio doors, you can create a space that blurs the lines between indoors and out.

\* Based on comparing written limited warranties of leading national wood window and wood patio door brands. See Pella written Limited Warranty for details, including exceptions and limitations, at [pella.com/warranty](http://pella.com/warranty) or contact Pella Customer Service at 877-473-5527.





Pella Reserve  
Traditional



### Historic elements

**Putty profile.** Further your aesthetic with the putty profile, recreated with historically accurate angles to provide meaningful depth and a realistic shadow. These products offer the industry's deepest sash dimension.

**Through-stile construction.** Essential to the tradition of window making, butt joinery and through-stile construction create authentic proportions and emulate historic window design.

**Integral Light Technology.** Pella's Integral Light Technology helps capture the look of true-divided-light without sacrificing energy performance.

### Intentional innovations

**Single- and double-hung Integrated Rolscreen.** The Integrated Rolscreen is a screen on a single- and double-hung window that appears when you open the window, and rolls away, out of sight, when you close it.

**Innovative sash lugs.** Add sash lugs to the exterior of our double-hung windows to create an authentic look, while maintaining modern tilting functionality for easy cleaning.

**Integrated security sensors.** Preserve the beauty of Pella Reserve windows and doors while protecting what matters most.

Available in these window and patio door styles:

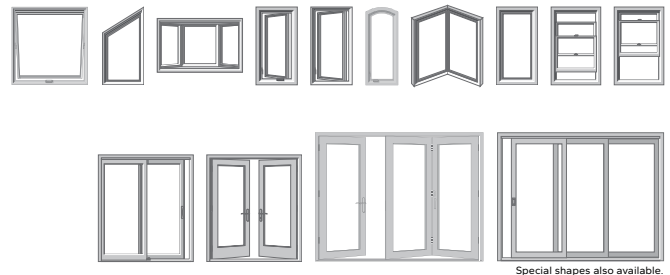

Special shapes also available.



### Pella® Reserve™ Contemporary Aluminum-Clad Wood

#### Clean lines

Add sleek, clean lines to your project with industry-leading modern designs.

#### 90° exterior profiles

Pella's patented cladding system delivers a clean sash joint with pure, 90-degree exteriors.

#### Modern hardware

Our renowned, exclusive hardware features sleek lines. The Saldo foldaway crank adds the perfect finishing touch.



Achieve your unique design vision without concessions with simple and sophisticated designs. With expansive glass, sleek, minimal profiles and through-style construction, this design embodies the tenets of pure contemporary style.

With uncompromised attention to detail, our cutting-edge innovations solve modern-day inconveniences. Add an expansive multi-slide or bifold patio door to your design for a space that blurs the lines between indoors and out. Preserve the beauty of Pella Reserve – Contemporary windows and doors while protecting what matters most with integrated security sensors. Windows and patio doors can be monitored from virtually anywhere with the free Pella Insynctive® App.<sup>1</sup> And we stand behind our products with the best limited lifetime warranty for wood windows and patio doors.<sup>2</sup>

<sup>1</sup> Requires the Pella Insynctive App on a smart device, an Insynctive Bridge and a wireless home internet router with internet connection.

<sup>2</sup> Based on comparing written limited warranties of leading national wood window and wood patio door brands. See Pella written Limited Warranty for details, including exceptions and limitations, at [pella.com/warranty](http://pella.com/warranty) or contact Pella Customer Service at 877-473-5527.





# PELLA® RESERVE™ CONTEMPORARY - ALUMINUM-CLAD WOOD

Pella Reserve  
Contemporary



## Clean lines

**Expansive glass.** Expansive glass combined with some of the narrowest sightlines in the industry allow you to bring your vision to life.

**Minimal profiles.** Our industry leading modern design delivers sleek, squared-off sash profiles. Square grille profiles provide another layer of design flexibility.

**Modern hardware.** Our renowned, exclusive hardware has set the bar for the industry. Featuring sleek lines, the Saldo foldaway crank adds the perfect finishing touch.

## Achieve your vision

**Durable, extruded aluminum.** Available in a wide variety of exterior colors or create your own unique exterior color to meet your design needs.

**Virtually unlimited customization.** From extra tall to extra wide. Custom sizes, grille patterns and designs, finishes, wood types and glass options are available.

**Tailor-made solutions.** From preliminary drawings to installation, Pella's expert team of architects, engineers, drafters and consultants can work to deliver custom window and door solutions for your project.

Available in these window and patio door styles:



Special shapes also available.



### Colors & Finishes

#### Wood Types



Choose the wood species that best complements your project's interior.

#### Custom solutions:



#### Prefinished Pine Interior Colors



When you select pine, we can prefinish in your choice of a variety of paint and stain colors. Unfinished or primed and ready-to-paint are also available.

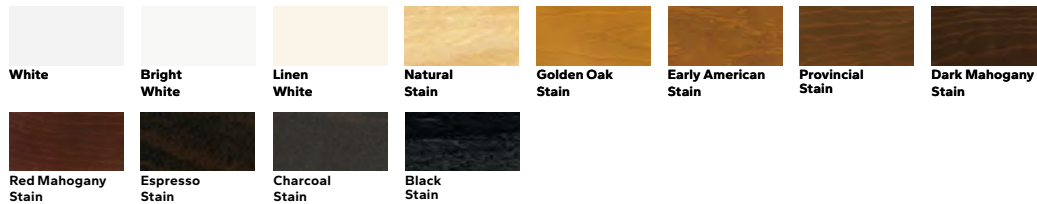

#### Extruded Aluminum-Clad Exterior Colors



Our low-maintenance EnduraClad® exterior finish resists chalking and fading. Take durability further with EnduraClad Plus protective finish, which meets the industry's highest exterior coating standard to defend against chalking and fading.<sup>1</sup> Custom colors are also available.



### Glass

#### InsulShield® Low-E Glass<sup>2</sup>



Advanced Low-E insulating dual-pane glass with argon or triple-pane glass with argon<sup>3</sup>



AdvancedComfort Low-E insulating dual-pane glass with argon



NaturalSun Low-E insulating dual-pane glass with argon or triple-pane glass with argon<sup>3</sup>



NaturalSun+ Low-E insulating dual-pane glass with argon



SunDefense™ Low-E insulating dual-pane glass with argon or triple-pane glass with argon<sup>3</sup>



SunDefense+ Low-E insulating dual-pane glass with argon



#### Additional Glass Options



Laminated (non-impact-resistant)<sup>4,5</sup>, tinted<sup>2,4</sup> or obscure<sup>2,4</sup> glass also available on select products

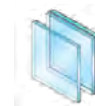

STC (Sound Transmission Class)-improved dual-pane sound glass<sup>5,6</sup>



Impact-resistant glass<sup>4,4</sup>



<sup>1</sup> The highest exterior coating standard for painted aluminum exteriors is the AAMA 2605 standard. EnduraClad Plus protective finish is not available with all colors. See your local Pella sales representative for availability.

<sup>2</sup> Optional high-altitude InsulShield Low-E glass is available with or without argon on select products.

<sup>3</sup> Available on select products only. See your local Pella sales representative for availability.

<sup>4</sup> Available with Low-E insulating glass with argon on select products.

<sup>5</sup> For best performance, the laminated glass may be in the interior or exterior pane of the insulating glass, depending on the product.

<sup>6</sup> Sound control glass consists of dissimilar glass thickness (3mm/5mm).



### Grilles

#### Grille Types

Choose the look of true divided light with Integral Light Technology® or make cleaning easier by selecting grilles-between-the-glass.



Ogee Integral Light Technology®  
7/8", 1-1/4"  
or 2"<sup>6</sup>

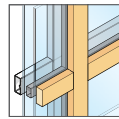

Square Integral Light Technology®  
5/8", 7/8",  
1-1/4" or 2"<sup>6</sup>



Aluminum Grilles-Between-the-Glass  
3/4"

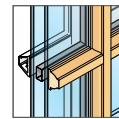

Putty Glaze Integral Light Technology® with Ogee Interior<sup>1</sup>  
5/8", 7/8", 1-1/4" or 2"



#### Grilles-Between-the-Glass Interior Colors:<sup>2</sup>



Black



White



Brown



Fossil



Ivory



Harvest



Cordovan

#### Grille Patterns

In addition to the patterns shown here, custom grille patterns are available.



12-Lite Prairie



14-Lite Prairie



Victorian



New England



Traditional



9-Lite Prairie



Top Row



Cross



Custom



Diamond



Simulated French



### Screens<sup>3</sup>

#### Rolscreen® & Integrated Rolscreen



Rolscreen soft-closing retractable screens roll out of sight when not in use on Pella Reserve – Traditional casement windows and sliding patio doors and on Pella Reserve – Contemporary sliding patio doors. The Integrated Rolscreen is a fully concealed Rolscreen that moves seamlessly with the sash – appearing when you open a Pella Reserve – Traditional single- or double-hung window and rolling completely away when you close it.

#### Flat



InView™ screens let in 14% more light and are 8% more open for improved airflow.<sup>4</sup>

### Added Peace of Mind

#### Integrated Security Sensors



Optional integrated wireless security sensors maintain aesthetics, streamline security installation and ensure no warranty loss is caused by post-installation drilling. Sensors can be monitored via the free Pella® Insynctive® App and are compatible with major security panel systems.<sup>5</sup> For more information, go to [connectpella.com](http://connectpella.com).

<sup>1</sup> Color-matched to your product's interior and exterior color.

<sup>2</sup> Appearance of exterior grille color may vary depending on the Low-E insulating glass selection.

<sup>3</sup> Warning: Use caution when children or pets are around open windows and doors. Screens are not designed to retain children or pets.

<sup>4</sup> Improved airflow is based on calculated screen cloth openness. Screen cloth transmittance was measured using an integrated sphere spectrophotometer.

<sup>5</sup> Requires the Insynctive App on a smart device, an Insynctive Bridge and a wireless home router with internet connection.





### Window Hardware

#### Classic Collection

T

Get a timeless look with authentic styles in classic finishes.



**Fold-Away Crank**  
Antiek



**Spoon-Style Lock**

Finishes:



Champagne

White

Brown

Matte Black



Oil-Rubbed Bronze



Satin Nickel



Satin Brass

#### Modern Collection

C

Achieve the ultimate contemporary look with exclusive hardware designed by Pella.



**Fold-Away Crank**  
Saldo

Finishes:

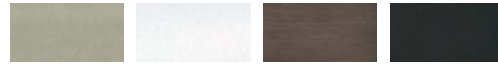

Champagne

White

Brown

Matte Black



Oil-Rubbed Bronze



Satin Nickel



Polished Chrome

Satin Brass

#### Rustic Collection

T

Create a distinct and charming look with distressed finishes.



**Fold-Away Crank**  
Antiek



**Spoon-Style Lock**

Finishes:



Distressed Bronze

Distressed Nickel

#### Essential Collection

T

Select from popular designs and finishes to suit every style.



**Fold-Away Crank**



**Cam-Action Lock**

Finishes:

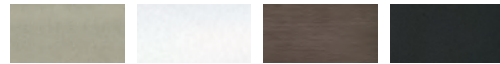

Champagne

White

Brown

Matte Black



Oil-Rubbed Bronze



Satin Nickel



Satin Brass



### Patio Door Hardware

#### Classic Collection



BALDWIN

Choose timeless pieces for a look that will never go out of style.



**Hinged & Bifold  
Patio Door Handles**  
Virago



**Sliding & Multi-Slide  
Patio Door Handle**  
Ambrose



**Multi-Slide  
Patio Door  
Handle<sup>1,2</sup>**

Finishes:



Matte  
Black



Oil-Rubbed  
Bronze



Satin  
Nickel



Satin  
Brass

#### Modern Collection



BALDWIN

Achieve the ultimate contemporary look with sleek finishes.



**Hinged & Bifold  
Patio Door Handle**  
Spiere



**Sliding & Multi-Slide  
Patio Door Handle**  
Plazo



**Multi-Slide  
Patio Door  
Handle<sup>1,2</sup>**

Finishes:



Matte  
Black



Satin  
Nickel

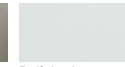

Polished  
Chrome



Satin  
Brass

#### Rustic Collection



BALDWIN

Stand out with bold looks and create an utterly unique aesthetic.



**Hinged & Bifold  
Patio Door Handles**  
Rustiek



**Sliding & Multi-Slide  
Patio Door Handle**  
Notus

Finishes:



Distressed  
Bronze

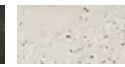

Distressed  
Nickel

#### Essential Collection



Elevate your style and transform a home with elegant selections.



**Hinged & Bifold  
Patio Door Handles**  
Standard



**Sliding Patio  
Door Handle**  
Standard



**Multi-Slide  
Patio Door  
Handle<sup>1,2</sup>**

Finishes:



Champagne



White



Brown



Matte  
Black



Oil-Rubbed  
Bronze



Satin  
Nickel



Satin  
Brass

<sup>1</sup> Flush multi-slide handle is a Pella exclusive design.  
<sup>2</sup> Flush multi-slide handle is not available in Champagne.

# PELLA® LIFESTYLE SERIES

## ALUMINUM-CLAD WOOD WINDOWS



### Pella® Lifestyle Series

Aluminum-Clad Wood

**#1 performing wood window and patio door<sup>1</sup>**

For the combination of energy, sound and value.

**37 time-tested innovations**

Create unique, room-by-room solutions to meet real-life needs.

**83% more energy efficient<sup>2</sup>**

On average compared to single-pane windows — with performance solutions for improved comfort.



Create solutions that are perfect for real life. Covered by the best limited lifetime warranty in the industry for wood windows and patio doors, Pella Lifestyle Series offers everything you love about wood — including beauty, durability and style flexibility.<sup>3</sup> Begin with dual- or triple-pane glass and then select from the most desired features and options.<sup>4</sup>

Pella Lifestyle Series is the #1 performing wood window and patio door for the combination of energy, sound and value.<sup>1</sup> Packed with purposeful innovations like the Hidden Screen and integrated blinds, shades and security sensors, we designed windows and patio doors to work for your project, room by room.





# PELLA® LIFESTYLE SERIES ALUMINUM-CLAD WOOD WINDOWS

Pella Lifestyle Series



## Exceptional performance and style.

**Style flexibility.** Whether your client's home is traditional, modern or somewhere in between, choose beautiful windows and patio doors that fit their style.

**Redefining performance.** Get both unrivaled energy efficiency and sound performance at an incredible value. With the Ultimate Performance package, windows are on average 79% more energy efficient and reduce 52% more outside noise than single-pane windows.<sup>2,5</sup>

**Enhanced durability.** Our windows are designed to stand the test of time with exterior wood parts treated with exclusive EnduraGuard® wood protection and an aluminum-clad exterior with EnduraClad® finish.

## Room-by-room solutions.

**Hidden Screen.** The innovative double-hung screen appears when the window is open and folds away when it is closed. It is easy to install and retrofittable.

**Integrated blinds and shades.** Intentionally designed to be accessible, blinds and shades are tucked between glass panes and are protected from dust, pets and little hands.

**Added security and convenience.** Add peace of mind with optional built-in window and door sensors and motorized between-the-glass blinds and shades that raise and lower with a touch of a button.

<sup>1</sup> Performance solutions require upgrades to triple-pane, AdvancedComfort Low-E and mixed glass thickness. Based on comparing product quotes and published STC/OITC and U-Factor ratings of leading national wood window and patio door brands.

<sup>2</sup> Window energy efficiency calculated in a computer simulation using RESFEN 6.0 default parameters for a 2000 sq. foot new construction single-story home when comparing Pella Lifestyle Series windows with Advanced Comfort Low-E triple-pane glass with argon and mixed glass thickness to a single-pane wood or vinyl window. Double-hung windows are not available with triple-pane glass. The energy efficiency and actual savings will vary by location. The average window energy efficiency is based on a national average of 94 modeled cities across the country and weighting based on population. For more details see pella.com/methodology.

<sup>3</sup> Based on comparing written limited warranties of leading national wood window and wood patio door brands. See Pella written Limited Warranty for details, including exceptions and limitations, at pella.com/warranty, or contact Pella Customer Service at 866-319-0397.

<sup>4</sup> Double-hung window only available with dual-pane glass.

<sup>5</sup> Reduction in sound based on OITC ratings of Pella Lifestyle Series windows with triple-pane glass with mixed glass thickness to a single-pane wood or vinyl window with an OITC of 19. Calculated by using the sound transmission loss values in the 80 to 4000 Hz range as measured in accordance with ASTM E-90(09). Actual results may vary.

## Available in these window and patio door styles:



Special shapes also available.



### Colors & Finishes

#### Wood Type

A beautiful wood species to complement a home's interior.



Pine

#### Prefinished Pine Interior Colors

We can prefinish in your choice of a variety of beautiful paints and stains. Unfinished or primed and ready-to-paint are also available.



White

Bright White

Linen White

Golden Oak Stain

Early American Stain

Provincial Stain

Black Stain

#### Aluminum-Clad Exterior Colors

Our low-maintenance EnduraClad® exterior finish resists fading and helps protect windows and patio doors for years.



Black

White

Brown

Fossil

Iron Ore

Portobello

Putty

Almond

Classic White

Brick Red

Hartford Green

Wolf Gray

### Glass<sup>1</sup>

#### InsulShield® Low-E Glass<sup>2</sup>



Advanced Low-E insulating dual-pane glass with argon or triple-pane glass with argon



AdvancedComfort Low-E insulating dual-pane glass with argon and triple-pane glass with argon



NaturalSun Low-E insulating dual-pane glass with argon or triple-pane glass with argon



NaturalSun+ Low-E insulating dual- or triple-pane glass with argon



SunDefense® Low-E insulating dual-pane glass with argon or triple-pane glass with argon



SunDefense+ Low-E insulating dual- or triple-pane glass with argon

#### Additional Glass Options



Tempered glass available on dual- and triple-pane products



Obscure and frosted obscure glass available on dual- and triple-pane products

<sup>1</sup> Double-hung window available with dual-pane glass only.

<sup>2</sup> Optional high-altitude Low-E insulating glass does not contain argon in most products. Please see your local Pella sales representative for more information.



# PELLA® LIFESTYLE SERIES

## FEATURES & OPTIONS

### Performance Packages

To make things easier, we've created performance packages that highlight what's most important to your customers.

Performance solutions offer an unbeatable combination of energy efficiency, sound control and value.<sup>1</sup> Upgrade from a dual- to a triple-pane glass design with the packages below to meet the unique needs of each room in your customer's home.

All values below are averages compared with single-pane windows.



#### Performance

Improved energy efficiency and sound performance.

**71%** + **34%**  
More Energy Efficient<sup>2</sup> + Noise Reduction<sup>3</sup>



#### Sound Control

Exceptional noise control for a quieter home.

**52%**  
Noise Reduction<sup>3</sup>



#### Energy Efficiency

Superior energy efficiency for a more comfortable home.

**83%**  
More Energy Efficient<sup>2</sup>



#### Ultimate Performance

The best combination of energy efficiency and noise control.

**79%** + **52%**  
More Energy Efficient<sup>2</sup> + Noise Reduction<sup>3</sup>



Scan the QR code with your smartphone camera to learn more about how each performance package can benefit your client's home.

<sup>1</sup> Performance solutions require upgrades to triple-pane, AdvancedComfort Low-E and mixed glazing thickness glass. Based on comparing product quotes and published STC/OITC and U-Factor ratings of leading national wood window and patio door brands.

<sup>2</sup> Window energy efficiency calculated in a computer simulation using RESFEN 6.0 default parameters for a 2000 sq. foot new construction single-story home when Pella Lifestyle Series windows with the respective performance package are compared to a single-pane wood or vinyl window. The energy efficiency and actual savings will vary by location. The average window energy efficiency is based on a national average of 94 modeled cities across the country and weighting based on population. For more details see [pella.com/methodology](http://pella.com/methodology).

<sup>3</sup> Reduction in sound based on OITC ratings of Pella Lifestyle Series windows with respective performance package compared to a single-pane wood or vinyl window with an OITC of 19. Calculated by using the sound transmission loss values in the 80 to 4000 Hz range as measured in accordance with ASTM E-90(09). Actual results may vary.





### Grilles

#### Grille Types

Choose the look of true divided light, or make cleaning easier by selecting grilles-between-the-glass.

##### Dual-Pane:



Simulated-Divided-Light with Spacer 7/8"<sup>1</sup>



Simulated-Divided-Light without Spacer 7/8"<sup>1</sup>



Aluminum Grilles-Between-The-Glass 3/4"<sup>2</sup>

##### Triple-Pane:



Aluminum Grilles-Between-The-Glass 3/4"<sup>2</sup>

#### Grille Patterns

In addition to the patterns shown here, custom grille patterns are available.



9-Lite Prairie



Traditional



Top Row



Cross



Custom

### Screens<sup>3</sup>

#### Rolscreen®

Rolscreen soft-closing retractable screens roll out of sight when not in use. Available on casement windows and sliding patio doors.

#### Hidden Screen

The exclusive, easy-to-use Hidden Screen appears when you open a double-hung window and folds away when the window is closed. It allows 44% more natural light into your home when a window is closed than a standard screen.<sup>4</sup>

#### Flat

InView™ screens are clearer than conventional screens and come standard.



InView™

### Added Peace of Mind

#### Integrated Security Sensors

Optional integrated wireless security sensors maintain aesthetics, streamline security installation and ensure no warranty loss is caused by post-installation drilling. Sensors can be monitored via the free Pella® Insynctive® App and are compatible with major security panel systems.<sup>5</sup> For more information, go to [connectpella.com](http://connectpella.com).

<sup>1</sup> Color-matched to your product's interior and exterior color.

<sup>2</sup> Appearance of exterior grille color may vary depending on the Low-E insulating glass selection.

<sup>3</sup> Warning: Use caution when children or pets are around open windows and doors. Screens are not designed to retain children or pets.

<sup>4</sup> Based on calculated screen cloth openness.

<sup>5</sup> Requires the Insynctive App on a smart device, an Insynctive Bridge and a wireless home router with internet connection.



# PELLA® LIFESTYLE SERIES

## FEATURES & OPTIONS

### Integrated Blinds & Shades

#### Integrated Blinds\*

Raise blinds up for an unobstructed view or tilt to let in the right amount of light. Our accessible, integrated blinds are available with or without motorization powered by Pella Insynctive® technology.

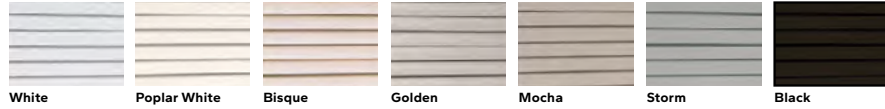

#### Integrated Shades\*

Our best integrated fabric shades feature a white exterior fabric for a uniform look from the street. Our accessible, integrated shades are available with or without motorization powered by Pella Insynctive® technology.

##### Light-Filtering:



##### Room-Darkening:



Haven't landed on the final blind or shade color yet? No problem.

With our patented triple-pane design, your customers can make the decision later in the process. Our triple-pane products come with all of the hardware to add blinds or shades before they arrive to the home or later in the building or remodeling process.



Scan the QR code with your smartphone camera to learn more about our motorized Insynctive blinds and shades.

### Window Hardware

#### Essential Collection

Our most popular designs with finishes to suit every style.



Fold-Away Crank



Cam-Action Lock

##### Finishes:

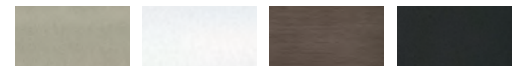

Champagne

White

Brown

Matte Black



Satin Nickel



Satin Brass

### Patio Door Hardware

#### Essential Collection

Elevate your style and transform a home with elegant selections.



Hinged Patio Door Handle



Sliding Patio Door Handle

##### Finishes:

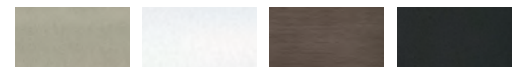

Champagne

White

Brown

Matte Black



Satin Nickel



Satin Brass

\* Available on triple-pane products only.



### Pella® Impervia®

Fiberglass

#### Unmatched strength & lasting durability

Made from our proprietary fiberglass, the strongest material available for windows and patio doors.<sup>1</sup>

#### Sleek, timeless style

Versatile design elements combined with sleek profiles and clean lines deliver a timeless style.

#### Proven performance

Get outstanding resistance to water, wind and outside noises while increasing energy efficiency, security and ease of operation.



Pella Impervia products are engineered to last. Our proprietary fiberglass material provides unmatched strength and lasting durability with sleek, timeless style.<sup>2</sup> And they balance thermal efficiency, scale and value when it matters most.

Don't leave water and structural performance to chance. Tested in extremes and designed for every day, Pella Impervia products are engineered for the rigorous performance requirements of a commercial building and are designed to resist water, wind and outside noises.<sup>3</sup> With nearly 100 years in business, it's rare to come across an application that we haven't already designed a robust installation for. We've got you covered with both products and an installation designed for your exact situation. And whether new construction or window replacement, we have a dedicated team of experts to help with your project.





# PELLA® IMPERVIA® FIBERGLASS WINDOWS

## Installation solutions & expertise

Save time and reduce costly callbacks with our exclusive installation methods. It's rare to come across an application that we haven't already solved for.

## Tested beyond requirements

Tested to extremes from -40°F to 180°F, our proprietary fiberglass can handle the most extreme heat and sub-cold.<sup>2</sup> Our products are tested beyond industry standards to help ensure less maintenance with fewer callbacks.

Pella Impervia



## Rigorously tested, optimized designs.

**100x more impact resistant than Fibrex.<sup>4</sup>** Pella Impervia products are made from our proprietary fiberglass material and are on average 100x more impact-resistant than Andersen Fibrex, a wood/plastic composite product. You can trust our fiberglass products to stand up to a hammer misfire and other jobsite conditions.

**Tested beyond requirements.** Tested to extremes from -40°F to 180°F, our proprietary fiberglass can handle the most extreme heat and sub-cold.<sup>2</sup> Our products are tested beyond industry standards to help ensure less maintenance with fewer callbacks.

**ENERGY STAR® certified.<sup>5</sup>** Pella Impervia products offer energy-efficient options that will meet or exceed ENERGY STAR guidelines in all 50 states.

## Sleek, versatile elements.

**Up-to-date color palette.** Interior and exterior color options to achieve your customer's unique design style, including Black. Our colors are a durable, powder-coat finish which resists chalking and fading.

**Revolutionary hardware.** Our patented Easy-Slide Operator allows your homeowner to simply slide to open casement and awning windows, without the effort of cranking. Select a complementary or contrasting hardware finish to add interest.

**Unique factory mulling.** Factory-mulled combinations help save you time on the jobsite. And the superior strength of Pella fiberglass allows you to create larger, unique combinations, made just for your remodel or new construction project.

Available in these window and patio door styles:



Special shapes also available.

<sup>1</sup> Pella's proprietary fiberglass material has displayed superior strength over wood, vinyl, aluminum, wood/plastic composites, and other fiberglass materials used by leading national brands in tensile and 3-point bend tests performed in accordance with ASTM D638 and D790 testing standards.

<sup>2</sup> In testing performed in accordance with ASTM testing standards, Pella's fiberglass has displayed superior performance in strength, ability to withstand extreme heat and cold and resistance to dents and scratches. Special shape windows are made from a fiberglass resin material.

<sup>3</sup> Pella Impervia windows and patio doors have a performance grade of LC or higher. For information on product ratings see [pella.com/performance](http://pella.com/performance).

<sup>4</sup> Impact testing performance based on testing 10 samples of each material using ASTM D256, Method C.

<sup>5</sup> Pella products may not meet ENERGY STAR guidelines in Canada. For more information, contact your local Pella sales representative or go to [energystar.gc.ca](http://energystar.gc.ca).



## FEATURES & OPTIONS

### Colors & Finishes

#### Frame Colors

Our long-lasting powder-coat finish resists chalking and fading so you never need to paint or refinish.

#### Solid-Color Frame:



#### Dual-Color Frame:<sup>1</sup>



### Glass & Additional Energy Efficiency Upgrades

#### InsulShield® Low-E Glass<sup>2</sup>



Advanced Low-E insulating dual- or triple-pane glass with argon



Advanced Comfort Low-E dual-pane glass with argon



NaturalSun Low-E insulating dual- or triple-pane glass with argon



NaturalSun+ Low-E insulating dual-pane glass with argon



SunDefense Low-E insulating dual- or triple-pane glass with argon



SunDefense+ Low-E insulating dual-pane glass with argon

#### Additional Glass Options



Bronze-tinted Advanced Low-E insulating glass with argon<sup>2</sup>

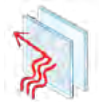

Obscure Low-E insulating glass



Tempered glass



Laminated (non-impact-resistant)<sup>3</sup> or tinted<sup>4</sup>

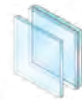

STC (Sound Transmission Class) dual-pane sound control glass<sup>5</sup>



Triple-pane glass<sup>6</sup>



Impact-resistant glass

#### Foam Insulation Options

Optional foam-insulated frames are available to increase energy efficiency.





### Grilles

#### Grilles

Grilles are color-matched to the window or patio door interior and exterior frame color.



Aluminum Grilles-  
Between-the-  
Glass 3/4"<sup>7</sup>

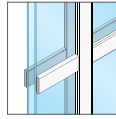

Applied  
Grilles<sup>8</sup>

#### Grille Patterns

Choose from one of our standard grille patterns, or create a unique look with custom grille patterns.<sup>9</sup>



Traditional



6-Lite Prairie



9-Lite Prairie



Top Row

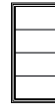

Custom

### Screens<sup>10</sup>

#### Flat Screen

InView™ screens let in 14% more light and are 8% more open for improved airflow when compared to the conventional fiberglass screen.<sup>11</sup>



InView™

<sup>1</sup> Dual-color frames are available with a block frame or non-integrated nailing fin.

<sup>2</sup> Optional high-altitude Low-E insulating glass available with or without argon on select products.

<sup>3</sup> For best performance, the laminated glass may be in the interior or exterior pane of the insulating glass, depending on the product.

<sup>4</sup> Available with Advanced Low-E insulating glass with argon with bronze, gray or green tint on selected products.

<sup>5</sup> Sound control glass consists of dissimilar glass thickness (3mm/5mm or 5mm/3mm).

<sup>6</sup> Available on direct set, awning, casement windows and sliding patio doors.

<sup>7</sup> Appearance of exterior grille color may vary depending on the Low-E insulating glass selection.

<sup>8</sup> Available on direct set windows only.

<sup>9</sup> Grille patterns offered may vary per product. See specific product information for availability.

<sup>10</sup> Warning: Screen will not stop child or pet from falling out of window or door. Keep child or pet away from open window or door.

<sup>11</sup> Improved airflow is based on calculated screen cloth openness. Screen cloth transmittance was measured using an integrated sphere spectrophotometer.



### Window Hardware

#### Casement & Awning

The patented Easy-Slide Operator is a revolutionary way to operate casement and awning windows. Simply slide to open, without the effort of cranking. With precision venting technology, the window will open to an exact location. Or select the fold-away crank, which folds neatly away against the window frame. Both solutions allow roomside window treatments to hang neatly.



Easy-Slide Operator



Fold-Away Crank

#### Color-Matched Finishes:



White

Brown

Matte Black

Tan

Morning Sky Gray

#### Additional Finish:



Satin Nickel

#### Sliding, Single- & Double-Hung

Pella's cam-action lock pulls the sash against the weatherstripping on single-hung, double-hung and sliding windows for a tighter seal.



Cam-Action Lock

#### Color-Matched Finishes:



White

Brown

Matte Black

Tan

Morning Sky Gray

#### Additional Finishes:

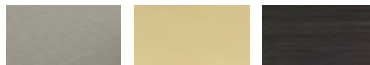

Satin Nickel

Bright Brass

Oil-Rubbed Bronze





### Patio Door Hardware

#### Sliding Patio Door

A multipoint lock is available in color-matched and upgraded finishes to complement your project.



Sliding Patio Door Handle

#### Color-Matched Finishes:

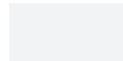

White



Brown

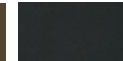

Matte Black



Tan



Morning Sky Gray

#### Additional Finish:



Satin Nickel

#### Secure Vent Lock

A secure vent lock comes standard on all Pella Impervia sliding doors and provides security in both the closed and venting positions.



Secure Vent Lock

#### Color-Matched Finishes:

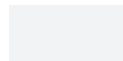

White



Brown

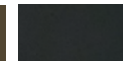

Matte Black



Tan



Morning Sky Gray

### Patio Door Blinds\*

#### Blinds-Between-the-Glass

Add privacy and complement a home's decor with blinds-between-the-glass. Located between panes of glass, blinds are protected from dust, dirt and damage.

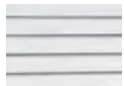

White



Slate Gray

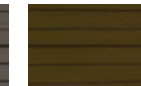

Espresso

\* Available on select sizes only. Contact your local Pella representative for more information.

# PELLA® 250 SERIES

## VINYL WINDOWS



### Pella® 250 Series

Vinyl

#### Innovative security and privacy features

Optional security and privacy features on windows and patio doors give your customers more peace of mind.

#### 52% stronger frames<sup>1</sup>

Multi-chambered vinyl frames and reinforced sashes are stronger than ordinary vinyl for increased durability.

#### 62% more energy efficient<sup>2</sup>

Windows with triple-pane glass create a more comfortable home than windows with single-pane glass.



Pella 250 Series products offer innovative and enhanced security and privacy features for more peace of mind. Our exclusive vinyl formula is performance tested for excellent weathering, durability and color retention. Insulating frame chambers improve energy efficiency and multi-chambered frame designs are 52% stronger than ordinary vinyl.<sup>1</sup>

With innovative and enhanced security and privacy features and our durable and low-maintenance, easy-care vinyl, Pella 250 Series windows and patio doors are a great complement to your project.

<sup>1</sup> Based on the force required to bend a window frame profile.

<sup>2</sup> Window energy efficiency calculated in a computer simulation using RESFEN 5.0 default parameters for a 2000 sq. foot existing single-story home when comparing a Pella 250 Series vinyl window with InsulShield Advanced Low-E triple pane glass with argon to a single paned wood or vinyl window. The range of energy efficiency will vary from 54% to 77% and will vary by location. Your actual savings will vary. The average window energy efficiency is based on a national average of 94 modeled cities across the country with an adjustment based on population. For more details see [pella.com/methodology](http://pella.com/methodology).

<sup>3</sup> To achieve a Grade 40 rating on ASTM F842, a test for forced entry excluding glass breakage, the optional footbolt must be installed and engaged.



# PELLA® 250 SERIES VINYL WINDOWS

Pella 250 Series



## Strong and Secure Vinyl.

**Improved security.** The classic sliding patio door with integrated footbolt meets or exceeds the highest industry requirements for forced entry and is our most secure vinyl patio door.<sup>3</sup>

**Unique tamper prevention system.** Double- and single-hung windows are designed with an interlocking checkrail, steel hardware reinforcement and a unique anti-jar sill.

**Strong vinyl material.** With multi-chambered frames and optional steel reinforced sashes, these frames are 52% stronger than ordinary vinyl, resist warping and twisting and install easily!

## More of Everything You Love.

**Excellent energy efficiency.** Multiple insulating air chambers deliver comfort for your customers. Upgraded triple-pane windows are on average 62% more energy efficient than single-pane windows.<sup>2</sup>

**Exclusive vinyl formula.** Using our exclusive fade-resistant formula, Pella's high-grade vinyl is performance-tested for excellent durability and weathering.

**Quality that lasts.** To help ensure our products exceed industry requirements and expectations, we test both the entire window and individual parts for strength and durability.

Available in these window and patio door styles:



Special shapes also available.



### Encompass by Pella®

Vinyl

#### Competitively priced

Easy-care, low-maintenance vinyl at a price that is easy on the budget.

#### Energy-efficient options

Offering solutions to improve comfort and help save on heating and cooling costs.

#### Backed by Pella

A leader in the window and door industry and a brand that has been trusted for nearly 100 years.



With Encompass by Pella, you can get windows and patio doors backed by the brand you know and trust, at a price that is easy on the budget.

Featuring low-maintenance, high-grade vinyl frames, these windows are energy efficient and look great for years. Lower heating and cooling costs with energy-efficient options that will meet or exceed ENERGY STAR® guidelines in all 50 states.<sup>1</sup>

<sup>1</sup> Some Pella products may not meet ENERGY STAR® guidelines in Canada. For more information, contact your local Pella sales representative or go to [energystar.gc.ca](http://energystar.gc.ca).

<sup>2</sup> The Pella Limited Lifetime Warranty is non-prorated, meaning the coverages within the defined warranty periods do not decrease over time. See written limited warranty for details, including exceptions and limitations, at [installpella.com/warranties](http://installpella.com/warranties), or contact Pella Customer Service at 866-319-0397.

<sup>3</sup> Double-hung window available in East Region only.





# PELLA® ENCOMPASS VINYL WINDOWS

Encompass by Pella



## Easy-care vinyl.

**Low-maintenance.** The solid color throughout keeps minor dings and scratches virtually invisible and doesn't require painting.

**More comfortable.** Pella's weather protection system helps protect a home from leaks and drafts.

**Stand the test of time.** Our precision welding process makes a strong and more durable product that resists warping and twisting.

## Designed to make life easier.

**Easy operation.** Pella's true glide balance system allows single- and double-hung windows to open and close easily and quietly.

**Dust-free grilles and blinds.** Never worry about cleaning between-the-glass grilles and blinds. Grilles-between-the-glass are sealed between glass on windows and patio doors and blinds-between-the-glass are sealed between glass on patio doors. This keeps the grilles and blinds safe from dust and damage.

**Limited lifetime warranty.** Backed by one of the best warranties in the business, you can be confident in your selection.<sup>2</sup>

Available in these window and patio door styles:<sup>3</sup>

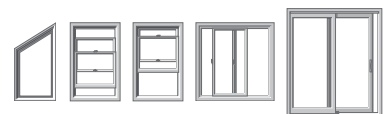

Special shapes also available.

# PELLA® 250 SERIES & ENCOMPASS

## FEATURES & OPTIONS



### Colors & Finishes

#### Frame Colors

Create a signature look with solid-color and dual-color frames. Dual-color frames allow your customers to choose a different color for the exterior with a White interior.

Solid-Color Frames: 250 ENC<sup>1</sup>



White

Almond

Fossil

Dual-Color Frames: 250



Brown

Black

### Glass & Additional Energy Efficiency Upgrades

#### InsulShield® Low-E Glass<sup>2</sup>



Advanced Low-E insulating dual-pane glass with argon<sup>3</sup>

250 ENC



Advanced Low-E insulating triple-pane glass with argon

250



NaturalSun Low-E insulating dual-pane glass with argon<sup>3</sup>

250 ENC



NaturalSun Low-E insulating triple-pane glass with argon

250



NaturalSun+ Low-E insulating dual-pane glass with argon

250 ENC



SunDefense™ Low-E insulating dual-pane glass with argon<sup>3</sup>

250 ENC



SunDefense+ Low-E insulating dual-pane glass with argon

250 ENC

#### Additional Glass Options



Bronze-tinted Advanced Low-E insulating glass with argon<sup>2</sup>

250

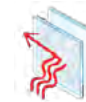

Obscure Low-E insulating glass

250 ENC



Tempered glass

250 ENC



Triple-pane glass

250

#### Foam Insulation Options

Optional foam-insulated frames are available to increase energy efficiency. 250 ENC<sup>1</sup>

<sup>1</sup> Feature availability varies by location. See local Pella representative for details.

<sup>2</sup> Optional high-altitude Low-E insulating glass available with or without argon on select products.

<sup>3</sup> Not available with blinds-between-the-glass on Encompass by Pella sliding patio doors.



# PELLA® 250 SERIES & ENCOMPASS

## FEATURES & OPTIONS

### Grilles

#### Grille Types

Grilles are color-matched to the window or patio door interior and exterior frame color.



Grilles-Between-the-Glass Flat 5/8<sup>1,2,3</sup>

250 ENC

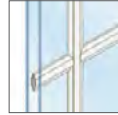

Grilles-Between-the-Glass Contour 3/4<sup>1,2</sup>

250 ENC

#### Grille Patterns

Choose from a variety of grille patterns for the traditional look of divided light.<sup>4</sup>



6-Lite Prairie

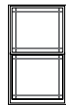

9-Lite Prairie



9-Lite Prairie Top Sash Only



Traditional



Traditional Top Sash Only



Top Row



Custom Equally Divided

### Screens<sup>5</sup>

#### Flat Window Screens

InView<sup>®</sup> screens are available on all venting vinyl windows and let in 14% more light and are 8% more open for improved airflow when compared to the conventional fiberglass screen.<sup>6</sup>

250 ENC

#### Sliding Patio Door Screens

Heavy-duty sliding screens come standard on Pella 250 Series sliding patio doors and are optional on Encompass by Pella sliding patio doors.

250 ENC

<sup>1</sup> Appearance of exterior grille color may vary depending on the Low-E insulating glass selection.

<sup>2</sup> Grilles are not available with blinds-between-the-glass on Encompass by Pella sliding patio doors.

<sup>3</sup> Available on Encompass by Pella products in West region only.

<sup>4</sup> Grille patterns offered may vary by product. See specific product information for availability.

<sup>5</sup> Warning: Use caution when children or pets are around open windows and doors. Screens are not designed to retain children or pets.

<sup>6</sup> Improved airflow is based on calculated screen cloth openness. Screen cloth transmittance was measured using an integrated sphere spectrophotometer.



## FEATURES & OPTIONS

### Window Hardware

#### Casement and Awning

Folds neatly out of the way so it won't interfere with roomside window treatments. Finishes complement frame colors.



**Fold-Away Crank**  
250

Color-Matched Finishes: 250



#### Sliding, Single- and Double-Hung

Pella's cam-action locks push the sashes against the weatherstripping for a tighter seal. Optional AutoLock hardware automatically locks the window when it is shut, simply close the sash and confirm it latches.



**Cam-Action Lock**  
250



**Cam-Action Lock**  
ENC



**AutoLock**  
250

Color-Matched Finishes: 250 ENC



#### Integrated Sash Lift

Make raising and lowering single- and double-hung window sashes easy with a standard, integrated sash lift.



**Window Integrated Sash Lift**  
250 ENC

Color-Matched Finishes: 250 ENC



#### Window Limited Opening Devices

A vent stop can be engaged or disengaged manually and restricts how far the bottom sash of a double-hung window can open. A window opening control device (WOCD) complies with a safety standard and allows for ventilation, emergency escape and rescue when released. A WOCD automatically limits the sash opening to less than four inches, unless it is intentionally disengaged, enabling the sash to fully open.



**Vent Stop**  
250 ENC



**WOCD**  
250 ENC

Color-Matched Finishes: 250 ENC







# PELLA® 250 SERIES & ENCOMPASS

## FEATURES & OPTIONS

### Patio Door Hardware

#### Sliding Patio Door Handle

Match the door's exterior color with a color-matched handle or coordinate it with other finishes in a home.



**Sliding Patio Door Handle**  
Standard Multipoint Locking System  
250



**Sliding Patio Door Handle**  
ENC

Color-Matched Finishes: 250 ENC



White



Almond



Fossil

Additional Interior Finishes: 250 ENC



Oil-Rubbed Bronze



Satin Nickel

#### Integrated Flush Footbolt

Pella 250 Series classic sliding patio door with integrated flush footbolt is our most secure vinyl patio door.<sup>1</sup> The patent-pending footbolt is flush with the frame, providing secondary venting and locking abilities without compromising beauty.



250

Color-Matched Finishes: 250



White



Almond



Fossil

### Patio Door Blinds

#### Blinds-Between-the-Glass<sup>2,3</sup>

Add privacy and complement your project's decor with blinds-between-the-glass. Located between panes of glass, blinds are protected from dust, pets and damage.

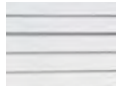

**White**  
250 ENC<sup>4</sup>



**Slate Gray**  
250



**Espresso**  
250

<sup>1</sup> To achieve a Grade 40 rating on ASTM F942, a test for forced entry excluding glass breakage, the optional footbolt must be installed and engaged.

<sup>2</sup> Availability varies by size. See a Pella professional for details.

<sup>3</sup> Available on dual-pane products only. Not available on sliding patio doors with grilles-between-the-glass.

<sup>4</sup> Only available on 60" x 80" and 72" x 80" doors.



Review our lines and discover your best fit.

<b>Product Line</b>	<b>Pella® Reserve™</b>		<b>Pella® Lifestyle Series</b>
	<b>Traditional</b>	<b>Contemporary</b>	
<b>Material</b>	Clad-Wood	Clad-Wood	Clad-Wood
<b>Price</b>	\$\$\$\$\$	\$\$\$\$\$	\$\$\$-\$\$\$\$\$
<b>Description</b>	Exquisitely designed windows and doors with unparalleled historical detailing. Featuring through-stile construction, deliberate proportions and intricate profiles to achieve authentic traditional style.	Simple and sophisticated designs with expansive glass, sleek, minimal profiles and through-stile construction embody the tenets of pure contemporary style.	Designed to deliver exceptional performance and create room-by-room solutions with time-tested innovations including the Hidden Screen and integrated blinds, shades and security sensors. Available performance solutions offer an unbeatable combination of energy efficiency, sound control and value. <sup>2</sup>
<b>Available Styles</b>	<p><b>Window Styles</b></p> <p>A AT B C CO DH F</p> <p>SH PC</p> <p><b>Patio Door Styles</b></p> <p>SD HD BF MS</p>	<p><b>Window Styles</b></p> <p>A AT C CO F</p> <p><b>Patio Door Styles</b></p> <p>SD HD BF MS</p>	<p><b>Window Styles</b></p> <p>A B C DH<sup>2</sup> F</p> <p><b>Patio Door Styles</b></p> <p>SD HD</p>

**Window & Patio Door Styles<sup>1</sup>**

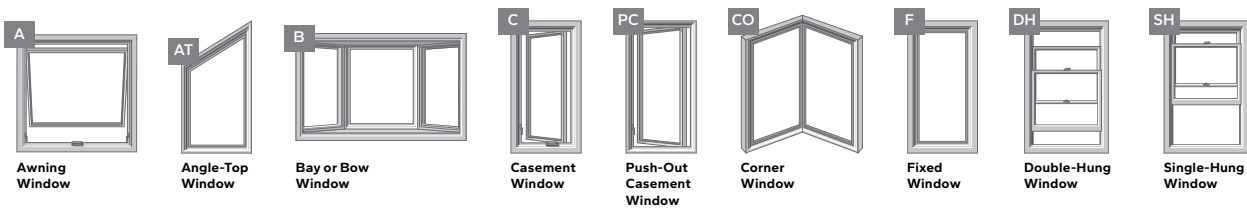



For more information on Pella's window and patio door offering, see your local Pella sales representative or visit [pellaprodealer.com](http://pellaprodealer.com).



**Pella Impervia®**

Fiberglass  
 \$\$\$-\$\$\$\$

Pella Impervia products are engineered to last. Our proprietary fiberglass material provides unmatched strength and lasting durability with sleek, timeless style.<sup>4</sup> Tested in extremes and designed for every day, these windows and patio doors deliver proven performance.

**Window Styles**

A AT B C DH F SH SW

**Patio Door Styles**

SD



**Pella 250 Series**

Vinyl  
 \$\$-\$\$\$

Pella 250 Series products offer innovative and enhanced security and privacy features for more peace of mind. Made with beautiful easy-care vinyl, these windows and patio doors provide Pella craftsmanship in a great-looking product.

**Window Styles**

A AT B C DH F SH SW

**Patio Door Styles**

SD



**Encompass by Pella**

Vinyl  
 \$

Encompass by Pella is competitively priced, easy-care vinyl. Featuring low-maintenance, high-grade vinyl frames, these windows and patio doors will look great for years and are backed by a brand you can trust.

**Window Styles**

AT DH<sup>2</sup> F SH SW

**Patio Door Styles**

SD

<sup>1</sup> Additional special shapes also available.  
<sup>2</sup> Performance solutions require upgrades to triple-pane, AdvancedComfort Low-E and mixed glass thickness. Based on comparing product quotes and published STC/QITC and U-Factor ratings of leading national wood window and patio door brands.  
<sup>3</sup> Double-hung window only available with dual-pane glass.  
<sup>4</sup> Pella's proprietary fiberglass material has displayed superior strength over wood, vinyl, aluminum, wood/plastic composites, and other fiberglass materials used by leading national brands in tensile and 3-point bend tests performed in accordance with ASTM D638 and D790 testing standards.  
<sup>5</sup> Double-hung window available in East Region only.



# WINDOW & DOOR TRIM OPTIONS

**Interior Wood Trim**

Dramatically reduce installation time with factory-applied and factory-finished trim. Pella's beautiful trim options provide a vast range of choices that are true to your customer's home architectural style and décor.

The trim around Pella® wood, fiberglass or vinyl windows and doors can coordinate with other trim on your project, including baseboards, crown molding and chair rails. Optional accessories to coordinate with trim profiles are available.

**Wood Types**

Choose the wood species that best complements your project's interior.

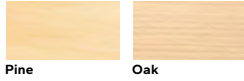

Pine

Oak

**Prefinished Pine Interior Colors**

Trim is available prefinished in your choice of a variety of paints and stains. Unfinished and ready-to-paint are also available.



White

Bright White

Linen White

Natural Stain

Golden Oak Stain

Early American Stain

Provincial Stain

Dark Mahogany Stain

Red Mahogany Stain

Espresso Stain

Charcoal Stain

Black Stain

**Interior Trim Styles\***

Choose from several styles of prefinished or unfinished wood interior trim to fit your project including these popular styles. Select trim styles available in Oak.



Craftsman

Ranch

Colonial

Curved



# WINDOW & DOOR TRIM OPTIONS

## EnduraClad® Exterior Trim

Add distinctive architectural detail to your project and set off the Pella wood windows and patio doors with style. Our low-maintenance, aluminum-clad exterior trim arrives factory-applied on windows and patio doors to save installation time and costs.

## Exterior Finish Colors

Our low-maintenance, aluminum EnduraClad® exterior finish resists chalking and fading. Custom colors are also available.



## Exterior Trim Styles

EnduraClad exterior aluminum trim is available in five standard profiles. Or choose a custom design.



## Installation Methods

Pella makes installing windows and doors easy. Multiple installation methods and exclusive features save time and help reduce costly callbacks.

For complete installation instructions and videos, visit [installpella.com](http://installpella.com).





# The Future of Window Installation is Here

---

Meet the **Pella® Steady Set™** Interior Installation System, the **industry's fastest, most labor efficient** wood window installation system with **uncompromising quality**.<sup>1</sup> The award-winning system is a safer way to install and is **3.15 times faster** and **utilizes less labor** than standard fin installation methods.<sup>2,3</sup> Plus, it is available at no additional cost.

Available on select new construction Pella Reserve™ and Pella Lifestyle Series windows.

<sup>1</sup> Comparing average install time and plumb/level/square measurements of leading national wood window brands when installed following the manufacturer's standard installation methods for new construction windows.

<sup>2</sup> Compared to the average of the leading national wood window brands installation methods for new construction windows when installing standard size window (29x59) into 2nd story application.

<sup>3</sup> Compared to leading national wood window brands recommended installation methods for new construction windows.



# STEADY SET™ INSTALLATION SYSTEM

## Pella® Steady Set™ Interior Installation System



### Head Stabilizer

- Engages with the header of the rough opening to help temporarily stabilize the unit
- Helps eliminate the need for someone to hold the unit from falling inwards prior to fastening
- Frees up a secondary installer to move on to other work

### Flashing Fin with Continuous Corners

- Pop-up yellow exterior fin is easily deployed after the window is set and helps ensure an exterior water barrier after being flashed
- Features a flexible hinge that naturally adapts to variation within the wall and an integrated corner seal allowing for a continuous seal

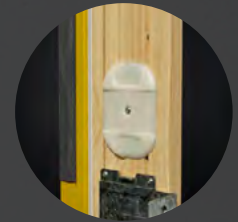
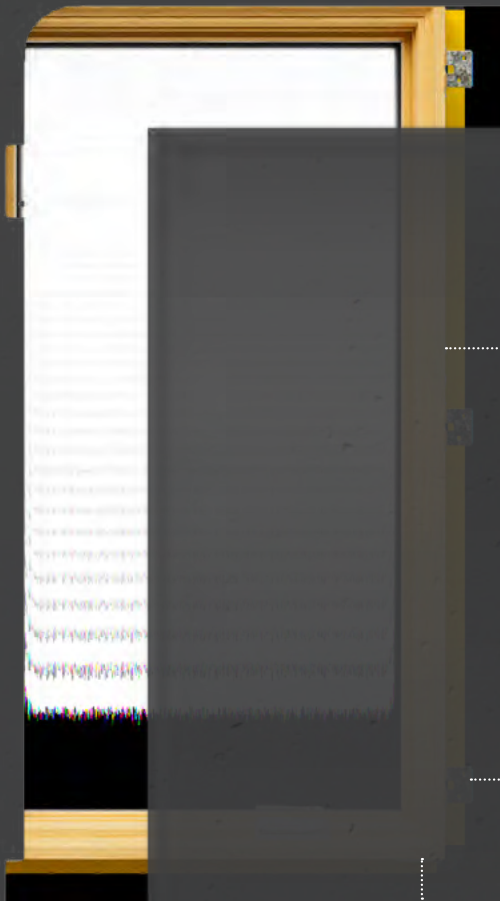
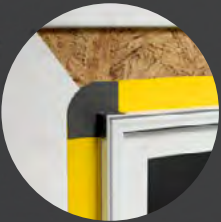

### Shim Guide

- Pre-attached to the jambs of select units
- Assists the installer by helping to hold shims in the correct location
- Can help ensure consistent frame to sash reveals

### Flip and Click Installation Bracket

- Comes pre-attached to the unit and helps enable a reliable, safe and simple install
- Simply needs to be unclipped, flipped and clicked to be install ready
- This structural attachment method securely attaches the window to the rough opening

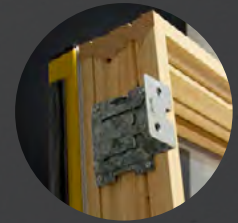

### Sill Shim

- Pre-applied sill shims raise the unit 1/4" off the rough opening sill, ensuring space for foam and/or sealant
- Gap allows for installers to easily insert tools to manipulate the unit
- Limits pinched fingers and product damage when leveling

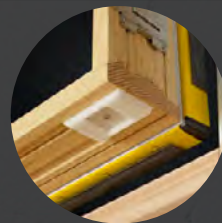



**MI**<sup>®</sup> **WINDOWS**  
**and DOORS**





MI®  
WINDOWS  
and DOORS

## V2000 Series Single-hung window

MODELS 1255 & 3500

Boasting a stylish look, these single-hung windows are favorites among builders and contractors for new home construction and replacement projects. The removable meeting rail, sash, and top-glass allow for easy drywall pass-through while multiple color options, stylish beveled profile, full-length lift rail, and metal reinforcements at the meeting rail provide homeowners with aesthetic options and desirable performance.



By MITER Brands™

### What you can expect

#### ENERGY-EFFICIENCY

Our dual-pane insulated glass helps save on heating and cooling costs while enhancing home comfort.

- In cool weather, it provides outstanding thermal performance to eliminate cold spots near windows.
- In warm weather, insulated glass reduces solar heat gain and minimizes interior glare.

#### CONVENIENCE AND STYLE

- Beveled exterior profile creates a clean, timeless aesthetic
- Surface-mounted, forced-entry-resistant locks provide a stronger, safer seal
- Full-length lift rail for easy opening and closing
- Tilt-in bottom sash for easy cleaning
- Optional window operating control device for enhanced safety

V2000 SERIES / MODELS 1255 & 3500



### Engineered to perform

- Welded, multi-chamber frame and sash
- Available frame styles: fin, finless
- Heavy-duty weatherstripping
- 2 7/8" frame depth
- Available with brickmould accessory and integral J-channel\*
- Wood extension jambs available for 4 1/16" and 6 1/16" wall depths

### Min and max sizing

WIDTH		HEIGHT	
MIN	MAX	MIN	MAX
13"	48"	24"	96"
CONTINUOUS HEAD & SILL (CHS) MAX			
Twin (Each Window)	47 1/2"	83 1/2"	
Twin (Overall Unit)	95 1/8"	83 1/2"	
Triple (Each Window)	35 3/4"	83 1/2"	
Triple (Overall Unit)	107 1/4"	83 1/2"	

Available in 1/4" increments. DP upgrade required for any unit greater than 84" tall. CHS available on XX, XO, OX, XXX, and XOX configurations.

### Energy efficient glass

Optional tempered glass adds additional strength and obscure or rain glass allows light in while protecting privacy.

GLAZING TYPE	U-VALUE	SHGC	STC
Low-E glass	0.33	0.28	28
Low-E glass with grids	0.33	0.26	28
Argon and Low-E glass	0.29	0.28	28
Argon and Low-E glass with grids	0.29	0.26	28
HP Low-E glass	0.33	0.21	28
HP Low-E glass with grids	0.33	0.19	28
Argon and HP Low-E glass	0.29	0.21	28
Argon and HP Low-E glass with grids	0.29	0.19	28

Note: all values based on standard 3/4" dual-pane insulated glass unit unless noted otherwise

**V2000 SERIES SINGLE HUNG WINDOW**  
See additional product and warranty information online.



### Create a customized look

Enhance your home's spaces with a variety of finish options and grid configurations.

#### FINISH OPTIONS

##### EXTERIOR

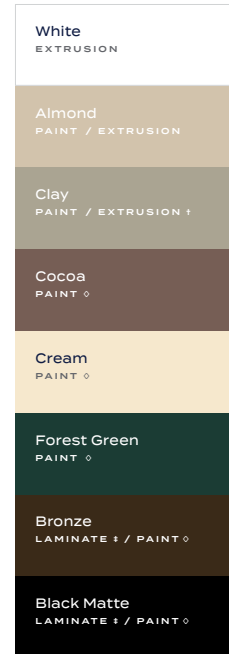

##### INTERIOR



#### GRID TYPES



\*J-Channel available on 3500 model only

† Clay interior available on products manufactured in Texas only; may only be combined with clay extruded exterior

‡ Exterior laminate available with white interior only; has a satin finish (matte applies to black paint only)

◊ Exterior paint not available with brickmould

**MI** Build boldly by choosing a range of MI window and door styles with expansive views, contemporary framing and hardware.

[miwindows.com/windows/V2000/single-hung](http://miwindows.com/windows/V2000/single-hung)

©2024 MI Windows and Doors, LLC. All rights reserved. MI-1255-3500-PDS 724

## V2000 VINYL MODEL 3540



MI®  
WINDOWS  
and DOORS

### V2000 Series Single-hung window

MODEL 3540

Boasting a stylish look, the 3540 single-hung window is specifically designed to meet high design pressure (DP) requirements for new home construction and remodeling and replacement projects. The removable meeting rail, sash, and top-glass allow for easy drywall pass-through while multiple color options, stylish beveled profile, full-length lift rail, and metal reinforcements at the meeting rail provide homeowners with aesthetic options and desirable performance.



### What you can expect

#### ENERGY-EFFICIENCY

Our dual-pane insulated glass helps save on heating and cooling costs while enhancing home comfort.

- In cool weather, it provides outstanding thermal performance to eliminate cold spots near windows.
- In warm weather, insulated glass reduces solar heat gain and minimizes interior glare.

#### CONVENIENCE AND STYLE

- Beveled exterior profile creates a clean, timeless aesthetic
- Surface-mounted tilt latches and forced-entry-resistant locks provide a stronger, safer seal
- Full-length lift rail for easy opening and closing
- Tilt-in bottom sash for easy cleaning
- Optional window operating control device for enhanced safety

By MITER Brands™

V2000 SERIES / MODEL 3540

### Engineered to perform

- Welded, multi-chamber frame and sash
- Heavy-duty weatherstripping
- Available frame styles: mounting fin, flange, finless
- 2 7/8" frame depth
- Available with brickmould accessory and integral J-channel
- Wood extension jambs available for 4 1/16" and 6 3/16" wall depths

### Min and max sizing

WIDTH		HEIGHT	
MIN	MAX	MIN	MAX
13"	48"	24"	96"
48"	52"	24"	84"
CONTINUOUS HEAD & SILL (CHS) MAX			
Twin (Each Window)	47 3/4"	84"	
Twin (Overall Unit)	95 5/8"	84"	
Triple (Each Window)	36"	84"	
Triple (Overall Unit)	108 1/4"	84"	

Available in 1/4" increments. DP upgrade required for any unit greater than 84" tall. CHS available on XX, XO, OX, XXX, and XOX configurations.

### Energy efficient glass

Optional tempered glass adds additional strength and obscure or rain glass allows light in while protecting privacy.

GLAZING TYPE	U-VALUE	SHGC	STC
Low-E glass	0.33	0.28	27
Low-E glass with grids	0.33	0.26	27
Argon and Low-E glass	0.30	0.28	27
Argon and Low-E glass with grids	0.30	0.26	27
HP Low-E glass	0.33	0.21	27
HP Low-E glass with grids	0.33	0.19	27
Argon and HP Low-E glass	0.30	0.21	27
Argon and HP Low-E glass with grids	0.30	0.19	27
Argon and LoE <sup>†</sup> -340 glass	0.30	0.15	27
Argon and LoE <sup>†</sup> -340 glass with grids	0.30	0.13	27

Note: all values based on standard 3/4" dual-pane insulated glass unit unless noted otherwise

**V2000 SERIES  
SINGLE-HUNG WINDOW**  
See additional product and warranty information online.



### Create a customized look

Enhance your home's spaces with a variety of finish options and grid configurations.

#### FINISH OPTIONS

##### EXTERIOR

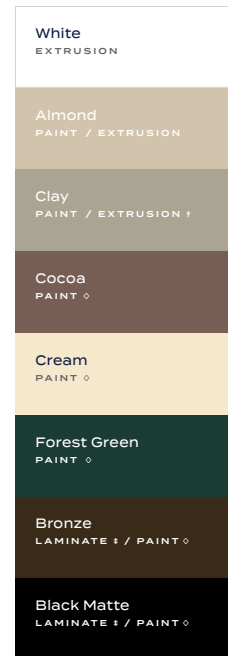

##### INTERIOR



#### GRID TYPES



† Clay interior available on products manufactured in Texas only; may only be combined with clay extruded exterior

‡ Exterior laminate available with white interior only; has a satin finish (matte applies to black paint only)

◊ Exterior paint not available with brickmould

**MI** Build boldly by choosing a range of MI window and door styles with expansive views, contemporary framing and hardware.

[miwindows.com/windows/V2000/single-hung](http://miwindows.com/windows/V2000/single-hung)

©2024 MI Windows and Doors, LLC. All rights reserved. MI-3540-PDS 724



### What you can expect

#### ENERGY EFFICIENCY

Our dual-pane insulated glass helps save on heating and cooling costs while enhancing home comfort.

- In cool weather, it provides outstanding thermal performance to eliminate cold spots near windows.
- In warm weather, insulated glass reduces solar heat gain and minimizes interior glare.

#### CONVENIENCE AND STYLE

- Beveled exterior profile creates a clean, timeless aesthetic
- Dual-opposing, mortised recessed locks create a stronger, safer seal
- Tilt-in top and bottom sash for easy cleaning
- Push-button vent stops enable ventilation without sacrificing safety and security
- Inverted-coil balances with detent clip provide smooth operation and prevent sash from drifting

By MITER Brands™

V2000 SERIES / MODEL 1555

**Engineered to perform**

- Welded, multi-chamber frame and sash
- Interlocking sash with heavy-duty weatherstripping
- Metal-reinforced meeting rail
- True-sloping sill
- 3 ¼" frame depth
- Available frame styles: finless, mounting fin
- Wood extension jambs available for 4 ½" and 6 ½" wall depths

**Min and max sizing**

WIDTH		HEIGHT	
MIN	MAX	MIN	MAX
15"	17"	28"	84"
17 ¼"	52"	23 ½"	60"

CONTINUOUS HEAD & SILL (CHS) MAX	
Twin (Each Window)	37 ¾"
Twin (Overall Unit)	75 ¾"
Triple (Each Window)	37 ¾"
Triple (Overall Unit)	113 ½"

Available in 1/8" increments. CHS available on XX and XXX configurations. 1555 Picture Window is not available with CHS.

**Energy efficient glass**

Optional tempered glass adds additional strength and obscure or rain glass allows light in while protecting privacy.

GLAZING TYPE	U-VALUE	SHGC
Argon and Low-E glass	0.28	0.26
Argon and Low-E glass with grids	0.28	0.23
Argon and Low-E DSB glass	0.28	0.26
Argon and Low-E DSB glass with grids	0.28	0.23
Argon and HP Low-E glass	0.29	0.21
Argon and HP Low-E glass with grids	0.29	0.19
Argon and HP Low-E DSB glass	0.28	0.21
Argon and HP Low-E DSB glass with grids	0.28	0.19

Note: all values based on standard 3/4" dual-pane insulated glass unit unless notes otherwise



**V2000 SERIES DOUBLE-HUNG WINDOW**  
See additional product and warranty information online.



**Create a customized look**

Enhance your home's spaces with a variety of finish options and grid configurations.

**FINISH OPTIONS**

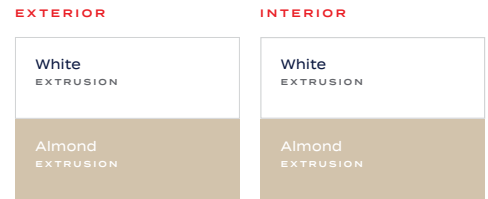

**GRID TYPES**



**MI<sup>®</sup>** Build boldly by choosing a range of MI window and door styles with expansive views, contemporary framing and hardware.

[miwindows.com/windows/V2000/double-hung](http://miwindows.com/windows/V2000/double-hung)



## V3000 VINYL MODEL 1620



MI®  
WINDOWS  
and DOORS

### V3000 Single-hung window

MODEL 1620

Designed for new home construction, remodeling, or replacement projects, the V3000 single-hung window is ideal for any home requiring a high-performance product. The slim profile allows for ample sunlight and unobstructed views, which is further enhanced by performance upgrades such as a DP-50 or StormArmor™ impact-resistant package designed for coastal regions.

### What you can expect

#### ENERGY EFFICIENCY

Our dual-pane insulated glass helps save on heating and cooling costs while enhancing home comfort.

- In cool weather, it provides outstanding thermal performance to eliminate cold spots near windows.
- In warm weather, insulated glass reduces solar heat gain and minimizes interior glare.

#### CONVENIENCE AND STYLE

- Brickmould exterior profile offers a timeless appeal
- Dual-opposing, mortised recessed locks create a stronger, safer seal
- Integral lift rail for easy opening and closing
- Tilt-in bottom sash for easy cleaning
- Inverted-coil balances provide smooth operation
- Push-button vent stops enable ventilation without sacrificing safety and security
- Optional window operating control device for enhanced safety



### Engineered to perform

- Welded, multi-chamber frame and sash
- 3 ¼" frame depth
- Heavy-duty weatherstripping
- Available frame styles: mounting fin, flange, finless
- Optional StormArmor™ package includes impact-resistant glass with argon, Cardinal LoE<sup>3</sup>-366, and preserve film to protect the glass until installation is complete
- Optional DP-50 package



### Min and max sizing

WIDTH		HEIGHT	
MIN	MAX	MIN	MAX
15"	48"	24 ½"	96"
48 ½"	52 ½"	24 ½"	74"
WITH STORMARMOR			
23"	52 ½"	24 ½"	75"

Available in 1/8" increments.

### Energy efficient glass

Optional tempered glass adds additional strength and obscure or rain glass allows light in while protecting privacy.

GLAZING TYPE	U-VALUE	SHGC	STC
Argon and Low-E glass	0.29	0.30	29
Argon and Low-E glass with grids	0.29	0.27	29
Argon and HP Low-E glass	0.29	0.22	29
Argon and HP Low-E glass with grids	0.29	0.20	29
Impact-resistant laminated glass with argon and LoE <sup>3</sup> -366	0.29	0.22	32
Impact-resistant laminated glass with argon and LoE <sup>3</sup> -366 with grids	0.29	0.20	32
Impact-resistant laminated glass with argon and LoE <sup>3</sup> -340	0.29	0.14	32
Impact-resistant laminated glass with argon and LoE <sup>3</sup> -340 with grids	0.29	0.13	32

Note: all values based on standard 3/4" dual-pane or 7/8" impact-resistant insulated glass unit unless noted otherwise

### Create a customized look

Enhance your home's spaces with a variety of finish options and grid configurations.

#### FINISH OPTIONS

EXTERIOR	INTERIOR
White EXTRUSION	White EXTRUSION
Almond EXTRUSION	Almond EXTRUSION
Clay EXTRUSION	Clay EXTRUSION
Bronze LAMINATE ‡	
Black LAMINATE ‡	

‡ Exterior laminate available with white interior only

#### GRID TYPES



**V3000 SINGLE-HUNG**  
See additional product and warranty information online.



Build boldly by choosing a range of MI window and door styles with expansive views, contemporary framing and hardware.

[miwindows.com/V3000](http://miwindows.com/V3000)



## V3000 Series Double-hung window

### MODEL 1556

Our top-selling double-hung window for new home construction, this V3000 Series double-hung window features superior styling, handcrafted quality, and exceptional long-term performance. Its stylish beveled exterior profile and eight exterior color options are complemented by energy-efficient options such as a warm-edge spacer system and insulated dual- or triple-pane glass.



## What you can expect

### ENERGY EFFICIENCY

Our dual- and triple-pane insulated glass package options help save on heating and cooling costs while enhancing home comfort.

- In cool weather, it provides outstanding thermal performance to eliminate cold spots near windows.
- In warm weather, insulated glass reduces solar heat gain and minimizes interior glare.

### CONVENIENCE AND STYLE

- Beveled exterior profile creates a timeless aesthetic
- Dual-opposing, mortised recessed locks create a stronger, safer seal
- Full FlexScreen™ with Clarity Screen™ mesh allows for optimal ventilation without compromising visibility
- True-sloping sill optimizes water drainage and eliminates unsightly weep holes
- Tilt-in top and bottom sash for easy cleaning
- Push-button vent stops enable ventilation without sacrificing safety and security
- Inverted-coil balances with detent clip provide smooth operation and prevent sash from drifting

### Engineered to perform

- Welded, multi-chamber frame and sash
- Interlocking sash
- Metal-reinforced meeting rail
- Available frame styles: mounting fin, finless
- 3 ¼" frame depth
- Wood extension jambs available for 4 ½" and 6 ½" wall depths
- Optional field-applied drywall returns, exterior brickmould, and factory-applied 3 ½" flat casing

### Min and max sizing

WIDTH		HEIGHT	
MIN	MAX	MIN	MAX
15"	48"	28"	80"
48 ½"	52 ½"	24 ½"	60"

CONTINUOUS HEAD & SILL (CHS) MAX	
Twin (Each Window)	47 ¾"
Twin (Overall Unit)	95 ⅝"
Triple (Each Window)	37 ¾"
Triple (Overall Unit)	113 ½"

Available in 1/8" increments. CHS available on XX and XXX configurations.

### Energy efficient glass

Optional tempered glass adds additional strength and obscure or rain glass allows light in while protecting privacy.

GLAZING TYPE	U-VALUE	SHGC	STC
Low-E glass	0.31	0.26	28
Low-E glass with grids	0.31	0.24	28
Argon and Low-E glass	0.28	0.26	28
Argon and Low-E glass with grids	0.28	0.23	28
Argon and Low-E DSB glass	0.28	0.26	30
Argon and Low-E DSB glass with grids	0.28	0.23	30
HP Low-E DSB glass	0.32	0.21	30
HP Low-E DSB glass with grids	0.32	0.19	30
Argon and HP Low-E DSB glass	0.28	0.21	30
Argon and HP Low-E DSB glass with grids	0.28	0.19	30
Argon and Low-E triple-pane glass	0.22	0.22	n/a
Argon and Low-E triple-pane glass with grids	0.23	0.20	n/a

Note: all values based on standard 3/4" dual-pane or 7/8" triple-pane insulated glass unit unless noted otherwise



**V3000 SERIES DOUBLE-HUNG WINDOW**  
See additional product and warranty information online.



### Create a customized look

Enhance your home's spaces with a variety of finish options and grid configurations.

#### FINISH OPTIONS

EXTERIOR	INTERIOR
White EXTRUSION	White EXTRUSION
Almond PAINT / EXTRUSION	Almond EXTRUSION
Clay PAINT	
Cocoa PAINT	
Cream PAINT	
Forest Green PAINT	
Bronze PAINT	
Black Matte PAINT †	

#### GRID TYPES



#### BLINDS-BETWEEN-THE-GLASS<sup>§</sup>



Optional addition to let you control sunlight and privacy without the need for bulky window treatments.

- SIX COLOR OPTIONS**
- White
  - Tan
  - Sand
  - Espresso
  - Slate gray
  - Silver moon

† Clay interior available on products manufactured in Texas only; may only be combined with clay extruded exterior; not available with foam or triple-pane glass  
 ‡ Woodgrain interior not available with black or clay exterior  
 § Blinds-between-the-glass available for dual-pane glass only

**MI<sup>®</sup>** Build boldly by choosing a range of MI window and door styles with expansive views, contemporary framing and hardware.

[miwindows.com/windows/V3000/double-hung](http://miwindows.com/windows/V3000/double-hung)





## V3000 Series Casement window

MODELS 1675 & 9770

Optimize your views of the outside and effortlessly allow fresh air inside with V3000 Series casement windows. An array of aesthetic options complement energy-efficient attributes, making V3000 Series casement windows the perfect addition to any new home construction, remodeling, or renovation project. Further enhance performance by selecting the StormArmor™ impact-resistant package designed for coastal regions with rigid performance requirements.



### What you can expect

#### ENERGY EFFICIENCY

Our dual- and triple-pane insulated glass package options help save on heating and cooling costs while enhancing home comfort.

- In cool weather, it provides outstanding thermal performance to eliminate cold spots near windows.
- In warm weather, insulated glass reduces solar heat gain and minimizes interior glare.

#### CONVENIENCE AND STYLE

- Triple weatherstripping for enhanced thermal performance
- Folding operator handle with easy-to-use crank mechanics creates a clean, modern aesthetic and delivers smooth, effortless operation
- 90° hinge capability provides maximum ventilation and airflow
- Multi-point locking hardware creates a tighter, safer seal
- Low-profile screen tabs result in an unobstructed view and simple screen removal



### Engineered to perform

- Welded, multi-chamber frame and sash
- 3 1/4" frame depth
- Available frame styles: finless, flange, mounting fin
- Exterior brickmould and 3 1/2" flat casing available on Model 9770
- Optional StormArmor™ package includes impact-resistant glass with argon, Cardinal LoE<sup>3</sup>-366, and preserve film to protect the glass until installation is complete
- Wood extension jambs available for 4 9/16" and 6 9/16" wall depths



### Min and max sizing

WIDTH		HEIGHT	
MIN	MAX	MIN	MAX
16"	36"	24"	74"
16"	40"	24"	72"

Available in 1/8" increments.

### Energy efficient glass

Optional tempered glass adds additional strength and obscure or rain glass allows light in while protecting privacy.

GLAZING TYPE	U-VALUE	SHGC	STC
Argon and Low-E glass	0.25	0.22	28
Argon and Low-E glass with grids	0.25	0.20	28
Argon and HP Low-E glass	0.26	0.18	28
Argon and HP Low-E glass with grids	0.26	0.16	28
Argon and Low-E triple-pane glass*	0.19	0.21	29
Argon and Low-E triple-pane glass with grids*	0.19	0.19	29
Impact-resistant laminated glass with Argon and LoE <sup>3</sup> -366	0.25	0.17	n/a
Impact-resistant laminated glass with Argon, LoE <sup>3</sup> -366, and grids	0.25	0.16	n/a
Impact-resistant laminated glass with Argon and LoE <sup>3</sup> -340	0.26	0.12	n/a
Impact-resistant laminated glass with Argon, LoE <sup>3</sup> -340, and grids	0.26	0.11	n/a

Note: all values based on standard 3/4" dual-pane or 1-1/8" triple-pane insulated glass unit unless noted otherwise

\*Qualifies for ENERGY STAR® Most Efficient tax credit.

† Clay interior may only be combined with clay extruded exterior; not available with triple-pane glass.

‡ Woodgrain interior not available with black or clay exterior; available on 1675 model only.

§ Black interior available with black laminate exterior only.

¶ Exterior laminate available with white interior or black interior; available only on 1675 model.

\*\* Blinds-between-the-glass available on 1675 model only; for dual-pane glass only; not available with StormArmor.

**V3000 SERIES CASEMENT WINDOW**  
See additional product and warranty information online.



### Create a customized look

Enhance your home's spaces with a variety of finish options and grid configurations.

#### FINISH OPTIONS

EXTERIOR	INTERIOR
White EXTRUSION	White EXTRUSION
Almond PAINT / EXTRUSION	Almond EXTRUSION
Clay PAINT / EXTRUSION	Clay EXTRUSION†
Cocoa PAINT	Hillside Oak LAMINATE‡
Cream PAINT	Natural Oak LAMINATE‡
Forest Green PAINT	Colonial Cherry LAMINATE‡
Bronze PAINT / LAMINATE¶	Black PAINT§
Black PAINT / LAMINATE¶	

#### GRID TYPES



#### BLINDS-BETWEEN-THE-GLASS\*\*



Optional addition to let you control sunlight and privacy without the need for bulky window treatments.

#### SIX COLOR OPTIONS

- White
- Espresso
- Tan
- Slate gray
- Sand
- Silver moon

**MI<sup>®</sup>** Build boldly by choosing a range of MI window and door styles with expansive views, contemporary framing and hardware.

[miwindows.com/windows/V3000/casement](http://miwindows.com/windows/V3000/casement)



MI®  
WINDOWS  
and DOORS

## V3000 Garden window

MODEL 2050

Boasting adjustable glass shelves that create an ideal setting for plants or collectibles, our V3000 garden window frees up precious counter space and exudes aesthetic charm. Its welded PVC vinyl frame provides long-term durability, and the fully screened side vents open a full 90 degrees to maximize airflow while keeping pests out.



### What you can expect

#### ENERGY-EFFICIENCY

Our dual-pane insulated glass helps save on heating and cooling costs while enhancing home comfort.

- In cool weather, it provides outstanding thermal performance to eliminate cold spots near windows.
- In warm weather, insulated glass reduces solar heat gain and minimizes interior glare.

#### CONVENIENCE AND STYLE

- Fully welded PVC vinyl frame provides long-term durability
- Aluminum and steel reinforcements in the front mullion improve structural performance
- Vents and deadlites have a built-in weep system for optimal water drainage
- FlexScreen™ allows for maximum airflow while keeping pests out
- Inside front-mounted multi-point locks and operators ensure safety and security
- Engineered for new construction and remodeling applications

**Engineered to perform**

- Shipped completely assembled and ready to install
- 1" insulated glass unit with dual-pane clear glass
- Top-sloped insulated tempered glass (constant 35° pitch)
- 1 ¼" exterior grade plywood head board, seat board, and jamb
- Available with adjustable glass shelves and finely-crafted edge banding and knee brace trim
- Optional Low-E and argon for increased thermal performance

**Min and max sizing**

WIDTH		HEIGHT	
PROJECTION: 17" CONSTANT			
MIN	MAX	MIN	MAX
24"	60"	30"	65"
60"	72"	30"	60"
IMPACT-RESISTANT			
24"	63"	30"	63"

**Create a customized look**

Enhance your home's spaces with a variety of finish options and grid configurations.

**FINISH OPTIONS**

**VINYL/EXTRUDED FRAME**



**SPECIALTY FRAME COLORS**

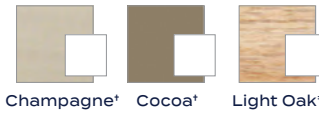

**HEAD BOARD, SEAT BOARD, AND JAMB**



**CORIAN SOLD-SURFACE SEAT BOARD**



† Champagne and Cocoa available on exterior with white interior only  
‡ Light Oak available on interior with white exterior only

**V3000 GARDEN**  
See additional product and warranty information online.



**MI**<sup>®</sup> Build boldly by choosing a range of MI window and door styles with expansive views, contemporary framing and hardware.

[miwindows.com/V3000](http://miwindows.com/V3000)







**ATRIUM**®  
W I N D O W S   A N D   D O O R S



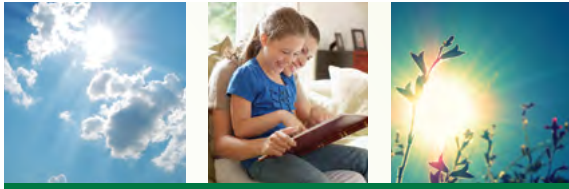

## SERIES 5700

### VINYL SIDE-LOAD SINGLE HUNG WINDOW

- + Removable bottom sash
- + Industry leading air infiltration performance
- + 1 ¼" Nail-fin setback for brick veneer construction and select stucco applications
- + Sweep lock helps provide a weather-tight seal and added security
- + Dual weather-stripping helps block air and water infiltration, keeping harsh elements outside and energy-saving comfort inside
- + Versatile half screen\* installs easily from inside
- + Double insulated glass provides energy saving efficiency. A host of glass options are available, including Low-E coatings and Argon Gas fill for additional efficiency and ENERGY STAR® compliance
- + Sloped sill reduces air infiltration and accommodates easy water run-off
- + Multi-chambered vinyl lineals improve thermal performance and enhance sound absorbency
- + Built-in accessory channels accommodate multiple installation options
- + Block and Tackle Balance System for ease of operation
- + Fusion-welded frame and sash minimizes water and air infiltration and enhances overall durability
- + Removable operable sash makes cleaning a breeze. Also includes full length interlock and bottom weather stripping
- + Limited lifetime warranty provides reassuring peace of mind
- + Pre-punched integral nail-fin targets proper nail location for quick, easy installation
- + Modular sized so that rough opening widths for multiple units are easy to calculate:
  - 5700 Single = 35.5"
  - 5700 Twin = 71.5"
  - 5700 Triple = 107.5"
- + DP Rating R50 (window size tested 36" x 96")
- + Jamb depth: 2.625"



### CUSTOM Options

- + Low-E Glass
- + Low-E Glass + Argon Gas
- + Ultra Low-E Glass + Argon Gas
- + ⅝" or ¾" flat, ⅝" or 1" contoured, ⅝" contoured valance grids available
- + Factory mulling of twins, triples and architectural shapes
- + Custom sizes available
- + Safety latch for sash restriction (field applied)
- + Paintable or stainable wood jamb extensions (4 ⅞" and 6 ⅞")



[www.atrium.com](http://www.atrium.com)



ENERGY STAR compliance available in all series. Verify product specifics before ordering.



### + COLOR OPTIONS\*\*

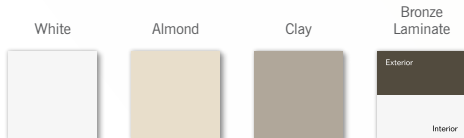

Note: Manufacturer reserves the right to substitute components as necessary for continued product improvement.  
 \* Screens are not meant to restrain a child from falling through an open window.  
 \*\* Printing process may affect color shown. Please refer to actual window sample when selecting colors. REV 2/20 TX

A DIVISION OF CORNERSTONE BUILDING BRANDS



## SERIES 5700

### VINYL HORIZONTAL SLIDING WINDOW

- + **1 ¼" Nail-fin setback** for brick veneer construction and select stucco applications
- + **Sweep lock** helps provide a weather-tight seal and added security
- + **Dual weather-stripping** helps block air and water infiltration, keeping harsh elements outside and energy-saving comfort inside
- + **Versatile half screen\*** installs easily from inside
- + **Double insulated glass** provides energy saving efficiency. A host of glass options are available, including Low-E coatings and Argon gas fill for additional efficiency and ENERGY STAR<sup>®</sup> compliance
- + **Multi-chambered vinyl lineals** improve thermal performance and enhance sound absorbency
- + **Fusion-welded frame and sash** minimizes water and air infiltration and enhances overall durability
- + **Metal reinforced meeting rail and sash rail** provide added durability and enhanced security
- + **Limited lifetime warranty** provides reassuring peace of mind
- + **Pre-punched integral nail-fin** targets proper nail location for quick, easy installation
- + **Tandem wheel and axle roller assemblies** ensure smooth, easy operation on even the largest sizes
- + **Multi-cavity vinyl lineals** improve thermal performance and enhance sound absorbency
- + **DP Rating R25**  
(window size tested 72" x 48")
- + **Jamb depth: 2.625"**



[www.atrium.com](http://www.atrium.com)

### CUSTOM Options

- + **Low-E Glass**
- + **Low-E Glass + Argon Gas**
- + **Ultra Low-E Glass + Argon Gas**
- + 5/8" or 3/4" flat, 5/8" or 1" contoured, 5/8" contoured valance grids available
- + Custom sizes available
- + Paintable or stainable wood jamb extensions (4 9/16" and 6 9/16")

### + COLOR OPTIONS\*\*

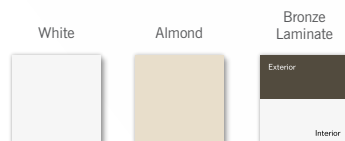

ENERGY STAR compliance available in all series. Verify product specifics before ordering.



Note: Manufacturer reserves the right to substitute components as necessary for continued product improvement.  
\* Screens are not meant to restrain a child from falling through an open window.  
\*\* Printing process may affect color shown. Please refer to actual window sample when selecting colors. REV 2/20 TX

A DIVISION OF CORNERSTONE BUILDING BRANDS

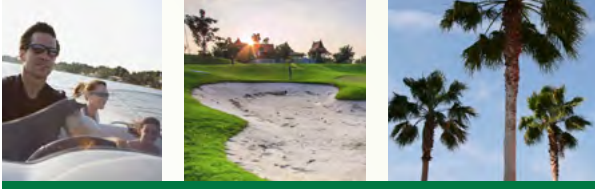

### SERIES 130 SINGLE HUNG WINDOW

Single hung, slider, picture windows and architectural shapes

- + **Bottom sash tilts in** for easy cleaning from inside
- + **Aluminum half screen** comes standard\*
- + **Block and tackle** balance system for easy sash movement
- + **Warm-Edge** spacer system provides energy saving thermal performance
- + **DP-50 rating** (window size tested 53" x 77")
- + **Aluminum reinforcement standard** in lock & meeting rails and sash stiles
- + **Dual Sweep locks** (standard at 27 1/4" and above) help provide a weather-tight seal and added security
- + **Dual weather-stripping** helps block air and water infiltration, keeping harsh elements outside and energy-saving comfort inside
- + **Step sill design** combines water run-off and aesthetic features of a sloped sill with the structural strength and internal drainage system of a pocket sill
- + **Jamb depth: 3"**
- + **Limited lifetime warranty**



Series 130 window shown with Nail Fin Only frame

### CUSTOM Options

- + **Low-E Glass**
- + **Low-E Glass + Argon Gas**
- + **Ultra Low-E Glass + Argon Gas**
- + Non-reflective Low-E Glass and Non-reflective Low-E Glass with Argon Gas
- + 1 1/8" simulated divided lite (SDL) grid
- + 5/8" or 1" contoured, 5/8" or 3/4" flat, 5/8" contoured valance grids
- + Nine painted exterior colors (white interior only)
- + Double strength and obscure glass
- + Charcoal aluminum half screen\*
- + Oriel style
- + Window Opening Control Device (WOCD)
- + Factory mulling and factory prepared mulling
- + Commodity sizing available
- + Custom sizes available



Step Bevel design creates a beautiful exterior appearance

### + COLOR OPTIONS\*\*

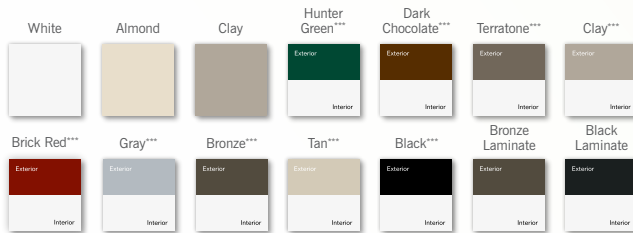

www.atrium.com



Select styles and glass packages can be ordered to meet ENERGY STAR® 7 guidelines. See your Atrium Territory Sales Manager for details.



### + FRAME TYPES FOUR OPTIONS:



Note: Manufacturer reserves the right to substitute components as necessary for continued product improvement.  
 \*\*Screens are not meant to restrain a child from falling through an open window.  
 \*\*\* Printing process may affect color shown. Please refer to actual window sample when selecting colors.  
 \*\*\*\* Grid offering limited to 5/8" contoured or SDL on exterior painted windows. Only use mild, water based household cleaner on painted product and rinse immediately with water. See full cleaning instructions for details. REV 11/23

A DIVISION OF CORNERSTONE BUILDING BRANDS



## SERIES 150 SINGLE HUNG WINDOW

Single hung, slider, picture windows and architectural shapes

- + Beautiful, true brick mould exterior frame perimeter
- + Bottom sash tilts in for easy cleaning
- + Fully welded frame and sash corners
- + Sloped sill for easy water run-off
- + DP-50 Rating (window size tested 36" x 74")
- + Integrated J-channel (Series 160 available without J-channel)
- + Pre-punched nail fin makes installation simple
- + Insulated glass panels with optimum thermal air space featuring warm-edge spacer system
- + Block and tackle balance system
- + Continuous head and sill on twins and triples
- + Half screen comes standard\*
- + Jamb depth: 3.277"
- + Matching slider series 151 available in 2- and 3-lite styles
- + Limited lifetime warranty

### CUSTOM Options

- + Low-E Glass
- + Low-E Glass + Argon Gas
- + Ultra Low-E Glass + Argon Gas
- + 5/8" or 3/4" flat, 5/8" or 1" contoured, 1 1/2" simulated divided lite (SDL), 5/8" contoured valance grids available
- + Nine painted exterior colors (white interior only)
- + Factory mulling of twins, triples and architectural shapes
- + Paintable or stainable wood jamb extensions (4 5/16" and 6 5/16")
- + Exterior 3 1/4" flat casing with Sill Nose DP-35 Rating (window size tested 36" x 74")
- + Charcoal aluminum mesh screen\*
- + Window Opening Control Device (W OCD)
- + Custom sizes available



Brick Mould Exterior

Pre-punched nailing fins and integrated J-channel

3 1/4" flat casing with sill nose



[www.atrium.com](http://www.atrium.com)



Select styles and glass packages can be ordered to meet ENERGY STAR<sup>®</sup> 7 guidelines. See your Atrium Territory Sales Manager for details.



**+ VINYL COLOR\*\* OPTIONS**

White	Almond	Clay

**+ EXTERIOR LAMINATE COLOR\*\* OPTION**

Black

Not available with: Series 160, SDL grid, or flat casing.

**+ PAINTED EXTERIOR COLOR\*\* OPTIONS**

Hunter Green***	Dark Chocolate***	Terratone***	Clay***
Brick Red***	Gray***	Bronze***	Tan***
			Black***

Note: Manufacturer reserves the right to substitute components as necessary for continued product improvement.  
 \*Screens are not meant to restrain a child from falling through an open window.  
 \*\*Printing process may affect color shown. Please refer to actual window sample when selecting colors.  
 \*\*\*Grid offering limited to 5/8" contoured or SDL on exterior painted windows. Only use mild, water based household cleaner on painted product and rinse immediately with water. See full cleaning instructions for details. REV 11/23

A DIVISION OF CORNERSTONE BUILDING BRANDS

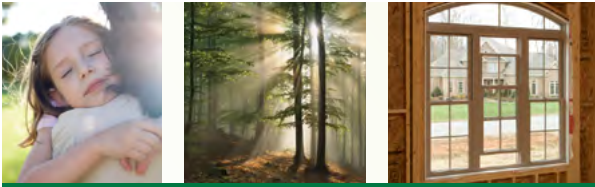

### SERIES 450 DOUBLE HUNG WINDOW

Double hung, picture windows and architectural shapes

- + Beautiful, true brick mould exterior frame perimeter
- + Both sashes tilt in for easy cleaning
- + Fully welded frame and sash corners
- + Sloped sill for easy water run-off
- + Insulated glass panels with optimum thermal air space featuring warm-edge spacer system
- + DP-35 Rating (available with DP-50 option, window size tested 36" x 74")
- + Series 455/465 available with DP-50 Rating
- + Integrated J-channel (Series 460 available without J-channel)
- + Pre-punched nail fin makes installation simple
- + Block and tackle balance system
- + Continuous head and sill on twins and triples
- + Half screen comes standard\*
- + Jamb depth: 3.868"
- + Matching slider #451 available in 2- and 3-lite styles
- + Limited lifetime warranty

### CUSTOM Options

- + Low-E Glass
- + Low-E Glass + Argon Gas
- + Ultra Low-E Glass + Argon Gas
- + Dual push-button night vents for secure ventilation
- + 5/8" or 3/4" flat, 5/8" or 1" contoured, 1 1/8" simulated divided lite (SDL), 5/8" contoured valance grids available
- + Nine painted exterior colors (white interior only)
- + Exterior 3 1/4" flat casing with Sill Nose
- + Factory mulling of twins, triples and architectural shapes
- + Paintable or stainable wood jamb extensions (4 1/16" and 6 1/16")
- + Brass or brushed nickel locks
- + Charcoal aluminum mesh screen\*
- + Window Opening Control Device (WOCD)
- + Custom sizes available



Featuring Our New Low Profile Lock



[www.atrium.com](http://www.atrium.com)



Select styles and glass packages can be ordered to meet ENERGY STAR® 7 guidelines. See your Atrium Territory Sales Manager for details.



Note: Manufacturer reserves the right to substitute components as necessary for continued product improvement.  
 \*Screens are not meant to restrain a child from falling through an open window.  
 \*\*Printing process may affect color shown. Please refer to actual window sample when selecting colors.  
 \*\*\*Grid offering limited to 5/8" contoured or SDL on exterior painted windows. Only use mild, water based household cleaner on painted product and rinse immediately with water. See full cleaning instructions for details. REV 11/23



Pre-punched nailing fins and integrated J-channel



3 1/4" flat casing with sill nose

### + COLOR OPTIONS\*\*

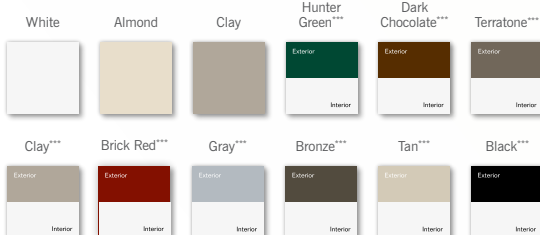



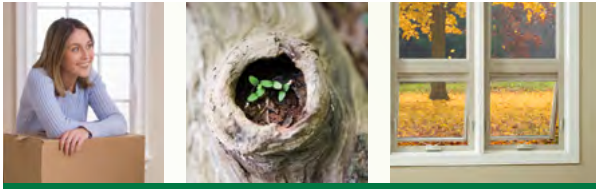

**SERIES 750** CASEMENT WINDOW

Series 755 awning window also available

- + Beautiful, true brick mould exterior frame perimeter
- + Low profile handle folds in and provides a popular aesthetic appeal
- + Narrow profile permits expanded viewing area
- + Fusion-welded frame and sash ensure weather-tight performance
- + Full-perimeter double weather stripping
- + Pre-punched nail fin makes installation simple
- + Insulated glass panels with optimum thermal air space featuring warm-edge spacer system
- + Concealed hinges and hardware let you open casement windows 90 degrees for better ventilation and easier cleaning
- + Full screens mount on the interior and are removable for easy cleaning\*
- + Tandem locks come standard on all casements over 34" in height
- + Jamb depth: 3.25"
- + Multi-point locking system provides superior pull-in mechanism with single lever
- + Limited Lifetime Warranty



Single vent casement

**CUSTOM Options**

- + Low-E Glass
- + Low-E Glass + Argon Gas
- + Ultra Low-E Glass + Argon Gas
- + 5/8" or 3/4" flat, 5/8" or 1" contoured, 1 1/8" simulated divided lite (SDL), 5/8" contoured valance grids available
- + 2" simulated meeting rail
- + Charcoal aluminum, Clear View and heavy duty screens\*\*
- + Nine painted exterior colors (white interior only)



Brick mould exterior



Low profile handle



Pre-punched nail fin



Single vent awning



[www.atrium.com](http://www.atrium.com)



Select styles and glass packages can be ordered to meet ENERGY STAR<sup>®</sup> 7 guidelines. See your Atrium Territory Sales Manager for details.



+ **COLOR**  
OPTIONS\*\*

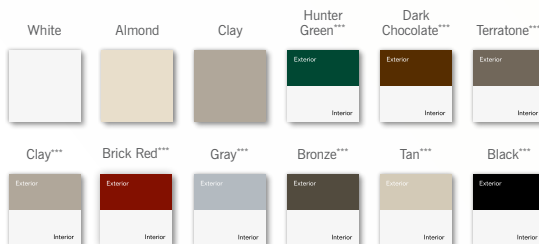

Note: Manufacturer reserves the right to substitute components as necessary for continued product improvement.  
 \*\*Screens are not meant to restrain a child from falling through an open window.  
 \*\*\* Printing process may affect color shown. Please refer to actual window sample when selecting colors.  
 \*\*\*\* Grid offering limited to 5/8" contoured or SDL on exterior painted windows. Only use mild, water based household cleaner on painted product and rinse immediately with water. See full cleaning instructions for details. REV 11/23

A DIVISION OF CORNERSTONE BUILDING BRANDS



### ENGINEERED FOR THAT PERFECT ARCHITECTURAL TOUCH

Create a window system that truly stands out—from octagons and trapezoids to full circles, half rounds, eyebrows and more, we can custom craft any specialty window to fulfill your visions.



Quarter Round



Colonial Arch



Colonial Arch Flanker



Colonial Flanker

- + Standard sizes are available plus a full range of architectural options to accommodate any building style, from colonial to contemporary, from Cape Cod to Southwest
- + Factory mulling is at your calling for quick, hassle-free installation
- + Insulated glass panels with optimum thermal air space featuring a warm-edge spacer system
- + Operable eyebrows and half eyebrows available in Series 150/160 operate sash
- + Optional wood jamb extensions (paintable or stainable pine 4 5/8" and 6 5/8" available)
- + Limited lifetime warranty



Operable Eyebrow



Half Round



Half Eyebrow



Oval



Full Round



Eyebrow Transom



Elliptical



Triangle



Octagon



Pentagon



Trapezoid

**Quarter Round**

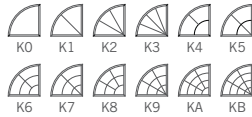

**Half Round**

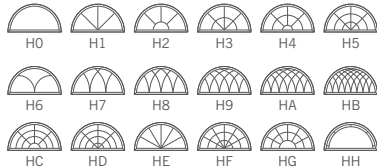

**Elliptical**



**Eyebrow Transom**

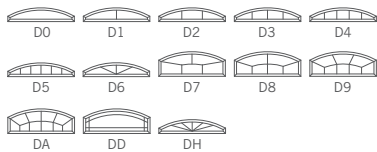

**Eyebrow**

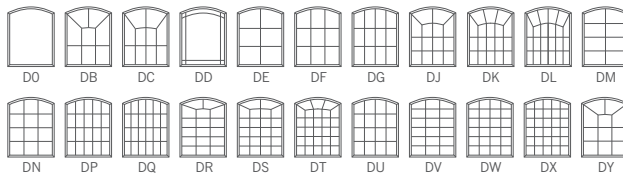

**Colonial Arch**

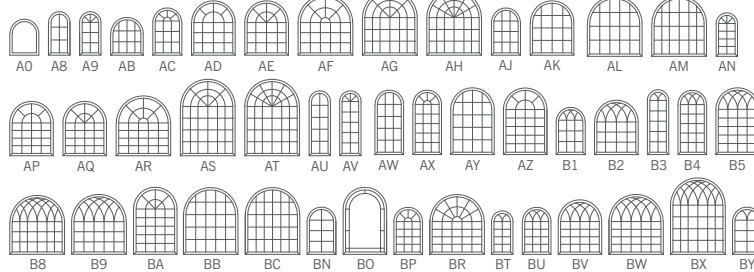

**Colonial Arch Flanker**

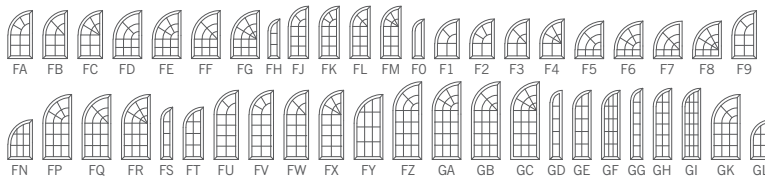

**Full Round**



**Oval**

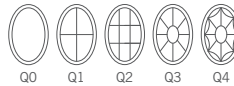

**Octagon**

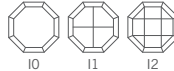

**Triangle**



**Trapezoid**



**Pentagon**

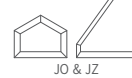

**Half Eyebrow**



**Colonial Flanker**



AVAILABLE OPTIONS FOR  
NEW CONSTRUCTION

- + Low-E Glass
- + Low-E Glass + Argon Gas
- + Ultra Low-E Glass + Argon Gas
- + Obscure glass
- + Double strength glass
- + 5/8" or 3/4" flat grid
- + 5/8" or 1" contoured grid
- + 1 1/8" Simulated Divided Lite grid (vertical or horizontal only)
- + White, Almond, Clay Vinyl Colors

AVAILABLE OPTIONS FOR  
REPLACEMENT

- + Low-E Glass
- + Low-E Glass + Argon Gas (standard on Series 8900 & 8700 only)
- + Ultra Low-E Glass + Argon Gas
- + Obscure glass
- + Double strength glass
- + 5/8" or 3/4" flat grid
- + 5/8" or 1" contoured grid
- + 1 1/8" Simulated Divided Lite grid (Series 8900 and 8700 only; vertical or horizontal only)
- + White, Almond Vinyl Colors
- + Interior Wood Laminates (Series 8900 only; no grid)
- + Exterior Bronze Laminate (Series 8700 only; no grid)
- + Nine Exterior Painted Colors (Series 8900 & 8300 only; no grid)
- + InsulKor Foam Filled Frame (Series 8900 only)
- + Super Spacer nXt Glass (Series 8900 only)
- + Triple Pane Low-E with Argon (Series 8900 only)
- + Triple Pane Ultra Low-E with Argon (Series 8900 only)
- + Decorative Glass (Series 8900 only)
- + Lifetime Glass Breakage Warranty (standard on 8900)

\* Printing process may affect color shown. Please refer to actual window sample when selecting colors.

Manufacturer reserves the right to substitute components as necessary. Screens are not meant to restrain a child from falling through an open window.

### A Wide Range of Grid Styles

Our between-the-panes and simulated divided lite (SDL) grid options enhance the cosmetic appeal of any home and make cleaning simple.

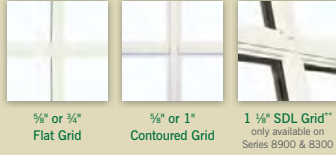

5/8" or 3/4" Flat Grid

5/8" or 1" Contoured Grid

1 1/2" SDL Grid™ only available on Series 8900 & 8300

### ENERGY SMART OPTIONS FROM ATRIUM

Atrium windows and doors are engineered with state-of-the-art glass technology to give you outstanding thermal efficiency. With a full range of glass options and special insulated spacers, we have a glass package to fit any climate need or budget.

### AVAILABLE COLOR OPTIONS FOR NEW CONSTRUCTION

#### + VINYL COLOR OPTIONS\*

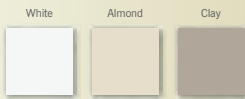

#### + PAINTED COLOR OPTIONS\*



### AVAILABLE COLOR OPTIONS FOR REPLACEMENT

#### + VINYL COLOR OPTIONS\*



#### + PAINTED COLOR OPTIONS\*

Note: Paint available only on Series 8900 & 8300; no grid



#### + LAMINATED COLOR OPTIONS\*

Note: Interior Wood Laminate available only on 8900; Exterior Bronze Laminate available only on 8700; no grid

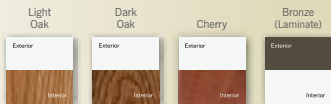

### ENERGY STAR Climate Zone Map

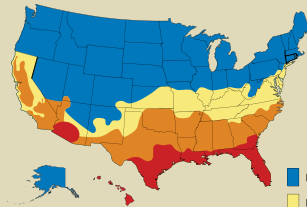

### Criteria for Windows

Climate Zone	U-Factor	SHGC	Prescriptive Equivalent Energy Performance
Northern	≤ 0.27	Any	Prescriptive Equivalent Energy Performance
	≥ 0.28	≥ 0.32	
	≥ 0.29	≥ 0.37	
North/Central	≤ 0.30	≥ 0.42	Prescriptive Equivalent Energy Performance
	≤ 0.30	≤ 0.40	
South/Central	≤ 0.30	≤ 0.25	Prescriptive Equivalent Energy Performance
Southern	≤ 0.40	≤ 0.25	
Air Leakage Rating:		≤ 0.3 cfm/ft²	

■ Northern Climate Zone    ■ South/Central Climate Zone  
 ■ North/Central Climate Zone    ■ Southern Climate Zone



ENERGY STAR compliance available in all series. Verify product specifics before ordering.



#### Low-E Glass

Low-E glass is coated with a microscopic layer of silver that reflects radiant solar energy while permitting visible light to pass through the glass, providing more comfort and lower energy costs.



#### Low-E Glass + Argon Gas

Argon gas works like an insulating blanket between two panes of glass to further improve thermal efficiency and decrease outside sound levels. (Standard on Series 8900 & 8700 only)



#### Ultra Low-E Glass + Argon Gas

Choose our ultimate glass package for optimal energy efficiency and maximum cost savings. Ultra Low-E glass offers three invisible layers of silver coating in addition to the superior thermal performance of argon gas.

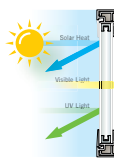

+ Low-E glass reduces heat gain from the sun in the summer, keeping your home cooler.



+ In the winter, Low-E glass lets the warm solar rays in while blocking the heat in your home from getting out.

energy efficient









## SIMULATED DIVIDED LITE (SDL) GRID

We are proud to offer a traditional simulated divided lite raised-style grid on interior and exterior window and door surfaces.

Simulated Divided Lite is available on the following products:

### Replacement

- + Series 8700 Double Hung
- + Series 8900 Double Hung
- + Series 700 Casement
- + Series 705 Awning

### New Construction

- + Series 130 Single Hung
- + Series 150 and Series 160 Single Hung
- + Series 450 and Series 460 Double Hung
- + Series 750 Casement
- + Series 755 Awning

### Patio Doors

- + Series 312 and 332

Also includes picture windows, architectural shapes and sliders of these series.



Series 8900 with SDL

## Features

- + A handcrafted look for any home, especially great for use in historical districts
- + Grids are color-matched and affixed permanently to the frame, providing the look of authentic divided lites
- + Grid size: 1 1/8"
- + One-week delivery

### + COLOR OPTIONS\*

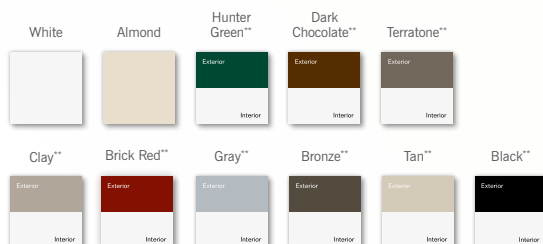

[www.atrium.com](http://www.atrium.com)



Select styles and glass packages can be ordered to meet ENERGY STAR® 7 guidelines. See your Atrium Territory Sales Manager for details.



Note: Manufacturer reserves the right to substitute components as necessary for continued product improvement.

\* Printing process may affect color shown. Please refer to actual window sample when selecting colors.  
 \*\* Grid offering limited to 5/8" contoured or SDL on exterior painted windows. Only use mild, water based household cleaner on painted product and rinse immediately with water. See full cleaning instructions for details. REV 11/23

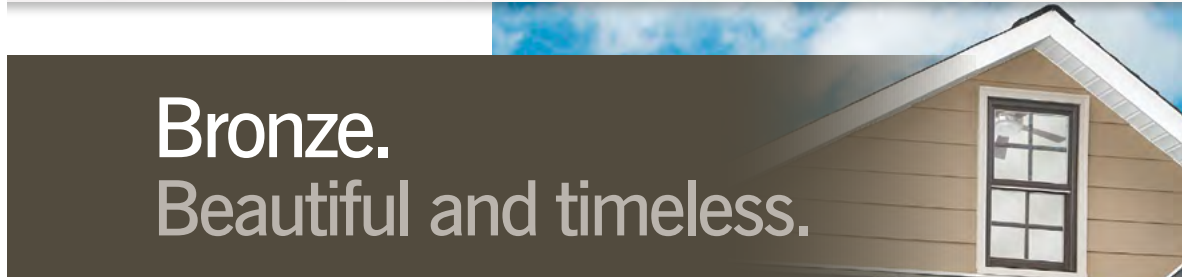

*Series 5700 shown here*  
bronze laminate exterior  
with white interior



**The beauty of bronze windows for your home.** Our bronze exterior laminate is available on:

**AVAILABLE ON:**

- + Series 5700 New Construction
- + Series 130 New Construction (available on fin only and box frames)
- + Series 8050 Replacement
- + Series 8700 Replacement (also available with contoured grid)

**AVAILABLE WITH:**

- + Single Hung and Picture Window Styles
- + 5/8" flat grid



5/8" Flat Grid  
(exterior view only)



5/8" or 1" Contoured Grid  
(exterior view only; available on 8700 only)

Contact your window representative for more details. **The timeless style of bronze.**



**Black windows are increasingly popular with homeowners. We are pleased to offer it on these quality Atrium products:**

**NEW CONSTRUCTION products:**

- SERIES 450 DOUBLE HUNG**  
(Including 455, 460, 465, 451 & 461)
- SERIES 150 SINGLE HUNG**  
(Including 160, 151, 161 & Operable Shapes)
- SERIES 130 SINGLE HUNG**  
(Including all Four Frame Types & Operable Shapes)
- SERIES 750 CASEMENTS**
- SERIES 755 AWNINGS**



**REPLACEMENT products:**

- SERIES 8900 DOUBLE HUNG**  
(Including Picture Windows and 2 & 3-Lite Sliders)
- SERIES 8300 DOUBLE HUNG**  
(Including Picture Windows and 2 & 3-Lite Sliders)
- SERIES 700 CASEMENTS**
- SERIES 705 AWNINGS**
- SERIES 312 & 332 SLIDING PATIO DOORS**  
\*Not available with 4 panel 12' patio doors

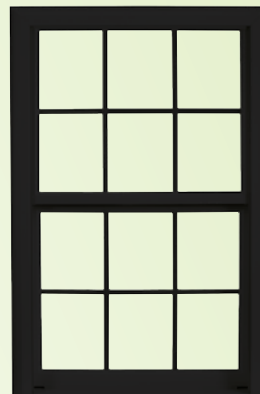

**+ PAINTED COLORS AVAILABLE\*\***

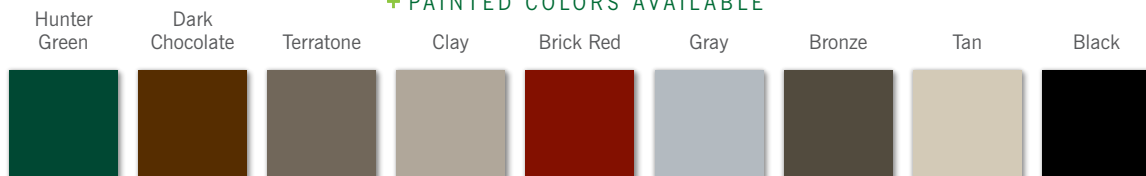

Color options can be purchased via WindowWizard. Available with white interior only.  
 5/8" contoured and SDL grid option available depending on particular Series. Contact Atrium representative or visit atrium.com for more details.

Note: Manufacturer reserves the right to substitute components as necessary for continued product improvement.  
 \*\*Printing process may affect color shown. Please refer to actual window sample when selecting colors.  
 Only use mild, water based household cleaner on painted product and rinse immediately













Krestmark<sup>®</sup>

**Westlake**  
Royal Window Solutions™

Krestmark® Collection  
**200-275 Series** – New Construction



Series 200 is cleanly designed with a smooth beveled exterior profile giving it a nice bold appearance. Series 275 has a profiled exterior simulating wood brick moulding. Available in Single Hung, Picture Window, Horizontal Slider and Architectural Shapes in White, Sandstone and Clay. Series 200 available in Black/White laminate.

- Multi-chambered, fusion-welded, extruded-vinyl frame and sash provides stability and strength, thermal-resistant properties, and is extremely low maintenance.
- Tilt-in removable bottom sash for ease of cleaning has dual sash locks on units 18" and wider, reducing air infiltration; recessed tilt latches, integral lift rail adds strength.
- Metal reinforced meeting rail for added strength, positive locking and reduced air infiltration.
- Sill features a combined sloped and weep system, ensuring quick and easy water run off.
- Integral pre-punched nail fin adds strength, a weather tight barrier and ease of installation.
- Dual-weatherstrip system reduces infiltration to meet or exceed national testing standards.
- Dual pane 3/4" clear insulated glass with Warm Edge Spacer.
- Block and tackle balances provide smooth operation; locking shoes prevent sash from falling out when tilting for cleaning or removal.

### Krestmark® Collection

### 200 Series – New Construction

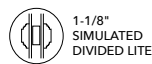
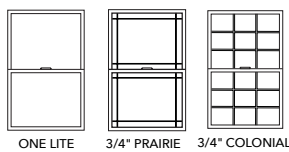
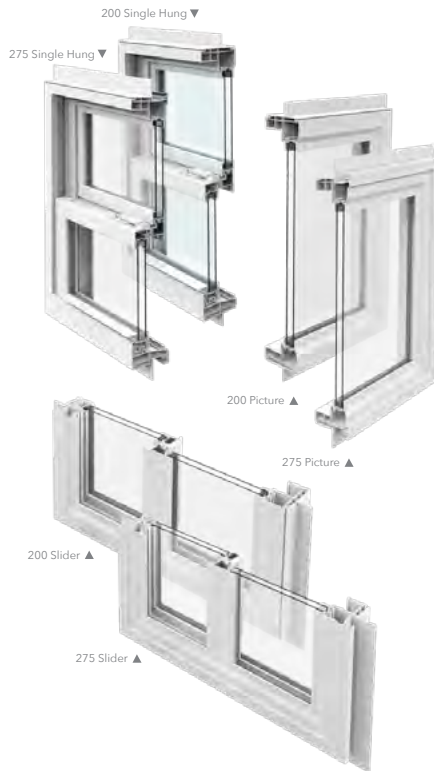

**CARDINAL IG**

#### NFRC PERFORMANCE RATINGS (3/4" overall IG with Quanex Duralite spacer)

SINGLE HUNG	Glass Type Exterior + Interior	Gap Fill	Grid Option	NFRC Performance Ratings			EnergyStar® v7 Climate Zone Compliance		
				U-F	SHGC	VT	Southern	S. Central	N. Central
Standard	LoE-366 + Clear	Air	no Grid	0.33	0.22	0.51	No	No	No
			with Grid	0.33	0.20	0.46	No	No	No
			Argon	0.30	0.22	0.51	Yes	No	No
STC rated (STC = 29) requires DSB + 3/16" glass thickness	LoE-366 + Clear	Argon	no Grid	0.33	0.22	0.50	No	No	No
			with Grid	0.33	0.20	0.45	No	No	No
			with Grid	0.29	0.22	0.50	Yes	No	No
			with Grid	0.29	0.20	0.45	Yes	No	No

HORIZONTAL SLIDER	Glass Type Exterior + Interior	Gap Fill	Grid Option	NFRC Performance Ratings			EnergyStar® v7 Climate Zone Compliance		
				U-F	SHGC	VT	Southern	S. Central	N. Central
Standard	LoE-366 + Clear	Air	no Grid	0.33	0.22	0.51	No	No	No
			with Grid	0.33	0.20	0.46	No	No	No
			Argon	0.29	0.22	0.51	Yes	No	No
STC rated (STC = 29) requires DSB + 3/16" glass thickness & 1 1/16" IG	LoE-366 + Clear	Argon	no Grid	0.34	0.22	0.51	No	No	No
			with Grid	0.35	0.20	0.45	No	No	No
			with Grid	0.29	0.22	0.51	Yes	No	No
			with Grid	0.30	0.20	0.45	Yes	No	No

PICTURE WINDOW	Glass Type Exterior + Interior	Gap Fill	Grid Option	NFRC Performance Ratings			EnergyStar® v7 Climate Zone Compliance		
				U-F	SHGC	VT	Southern	S. Central	N. Central
Standard	LoE-366 + Clear	Air	no Grid	0.32	0.23	0.54	Yes	No	No
			with Grid	0.32	0.21	0.49	Yes	No	No
			Argon	0.28	0.23	0.54	Yes	Yes	No
STC rated (STC = 31) requires DSB + 3/16" glass thickness & 1 1/16" IG	LoE-366 + Clear	Argon	no Grid	0.34	0.24	0.53	No	No	No
			with Grid	0.36	0.22	0.48	No	No	No
			with Grid	0.29	0.23	0.53	Yes	No	No
			with Grid	0.30	0.21	0.48	Yes	No	No

Unless specified, the NFRC values & Energy Star compliance are for double glazed, SSB (3/32") glass thickness. For glass thicknesses above this, contact your sales representative for ratings information.

Please visit [WestlakeRoyalWindows.com](http://WestlakeRoyalWindows.com) for more information.

You may qualify for a tax credit when you replace your existing windows. For more information, go to [energystar.gov](http://energystar.gov)



**Westlake**  
Royal Window Solutions™

Krestmark® Collection  
**250 Series** – New Construction



The Series 250 casement, awning and picture windows are primarily used for new construction. The actual unit size, however, is 1/2" under call out and is manufactured in some of the most common sizes used for replacement window installations. For some of these replacement applications the integral nail fin could be removed.

- Multi-chambered, extruded vinyl frame and sash provide stability with excellent strength, thermal-resistant properties and is extremely low maintenance.
- Fusion-welded corners in frame and sash provides strength and virtually eliminates air and water infiltration.
- Single, twin and triple casements, awnings, picture combinations, 1/4 and 1/2 rounds, arches and eyebrows are available as mullied transoms.
- 3/4" insulated glass, warm-edge spacer, energy-efficient LoE coating option. Type and look of warm edge spacer may vary.
- Multi-point locking hardware with hinged-side snubber, folding handle to minimize window treatment interference, and sash alignment wheel.
- Dual-durometer, double weather strip, energy-efficient system with welded corners for excellent performance and resistance to weather penetration.
- Certifications of all products tested are done to meet or exceed national testing standards by NFRC and AAMA; Energy Star® partner; TDI approval.
- Argon-enhanced glass improves energy efficiency.
- Tempered obscure, bronze or grey glass; 3/4" dual-insulated clear glass.
- Grille patterns: 3/4" Colonial, Prairie, 1" Contoured and 1-1/8" Simulated Divided Lite.
- Factory mullied or stacked units and field mull accessories.

Note: All picture windows, shapes and one-frame glass larger than 30 square feet will come with Tempered Glass as standard for safety reasons. All additional charges for Tempered Glass will automatically be applied.

### Krestmark® Collection

### 250 Series – New Construction



#### NFRC PERFORMANCE RATINGS (3/4" overall IG with Quanex Duralite spacer)

CASEMENT	Glass Type Exterior + Interior	Gap Fill	Grid Option	NFRC Performance Ratings			EnergyStar® v7 Climate Zone Compliance		
				U-F	SHGC	VT	Southern	S.Central	N.Central
				Standard	LoE-366 + Clear	Air	no Grid	0.30	0.19
	Air	with Grid	0.30	0.17		0.38	Yes	No	No
	Argon	no Grid	0.27	0.18		0.43	Yes	Yes	No
	Argon	with Grid	0.27	0.17		0.38	Yes	Yes	No

AWNING	Glass Type Exterior + Interior	Gap Fill	Grid Option	NFRC Performance Ratings			EnergyStar® v7 Climate Zone Compliance		
				U-F	SHGC	VT	Southern	S.Central	N.Central
				Standard	LoE-366 + Clear	Air	no Grid	0.30	0.19
	Air	with Grid	0.30	0.17		0.38	Yes	No	No
	Argon	no Grid	0.27	0.18		0.43	Yes	Yes	No
	Argon	with Grid	0.27	0.17		0.38	Yes	Yes	No

PICTURE WINDOW	Glass Type Exterior + Interior	Gap Fill	Grid Option	NFRC Performance Ratings			EnergyStar® v7 Climate Zone Compliance		
				U-F	SHGC	VT	Southern	S.Central	N.Central
				Standard	LoE-366 + Clear	Air	no Grid	0.29	0.22
	Air	with Grid	0.29	0.20		0.45	Yes	No	No
	Argon	no Grid	0.26	0.21		0.51	Yes	Yes	No
	Argon	with Grid	0.26	0.19		0.45	Yes	Yes	No

Unless specified, the NFRC values & Energy Star compliance are for double glazed, SSB (3/32") glass thickness. For glass thicknesses above this, contact your sales representative for ratings information.

Please visit [WestlakeRoyalWindows.com](http://WestlakeRoyalWindows.com) for more Energy Star options.

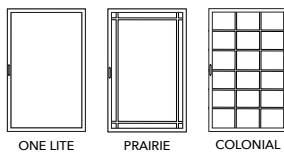

**CARDINAL IG**

You may qualify for a tax credit when you replace your existing windows. For more information, go to [energystar.gov](http://energystar.gov)





**Westlake**  
Royal Window Solutions™

Krestmark® Collection  
400 Series – New Construction



The 400 Series Window is primarily a new construction window but should not be ruled out for remodeling or replacement applications. Available in Single Hung, Horizontal Slider, Picture Window, architectural shapes and mulled units.

- Multi-chambered extruded vinyl frame and sash provide stability with excellent strength, thermal-resistant properties and is extremely low maintenance.
- Integral pre-punched nail fin adds strength, is a weathertight barrier and provides ease of installation.
- Fusion-welded corners in frame and sash provide strength and virtually eliminates air and water infiltration.
- Dual pane 3/4" insulated glass with environmentally friendly Warm Edge Spacer reduces thermal loss (type may vary).
- All picture windows, shapes and one-frame glass larger than 30 square feet will come with Tempered Glass as standard for safety reasons. All additional charges for Tempered Glass will automatically be applied.

### Krestmark® Collection

### 400 Series – New Construction



Argon-enhanced glass improves energy efficiency.

E66 is a light green tint and provides the most efficient U-Factor & SHGC.

Tempered, obscure, bronze or grey glass.

Factory muller or stacked units and field mull accessories.

Impact available for coastal areas, added security or sound dampening (See Series 4000).

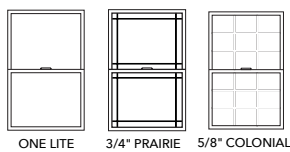

ONE LITE    3/4" PRAIRIE    5/8" COLONIAL



SIMULATED DIVIDED LITE



GRILLE BETWEEN GLASS



WHITE    SANDSTONE    CLAY

**CARDINAL IG**

### NFRC PERFORMANCE RATINGS (3/4" overall IG with Quanex Duralite spacer)

SINGLE HUNG	Glass Type Exterior + Interior	Gap Fill	Grid Option	NFRC Performance Ratings			EnergyStar® v7 Climate Zone Compliance			
				U-F	SHGC	VT	Southern	S.Central	N.Central	
Standard	LoE-366 + Clear	Air	no Grid	0.32	0.23	0.54	Yes	No	No	
			with Grid	0.32	0.21	0.48	Yes	No	No	
			Argon	0.28	0.21	0.48	Yes	Yes	No	
IMPACT rated (Missile-D) Requires DSB + 6.9L glass	LoE-366 + Clear	Air	no Grid	0.34	0.23	0.53	No	No	No	
			with Grid	0.35	0.21	0.48	No	No	No	
			Argon	0.29	0.23	0.53	Yes	No	No	
STC rated (STC = 32) requires DSB + 3/16" glass thickness & 11/16" IG	LoE-366 + Clear	Air	no Grid	0.34	0.24	0.53	No	No	No	
			with Grid	0.35	0.21	0.48	No	No	No	
			Argon	0.29	0.23	0.53	Yes	No	No	
			Argon	with Grid	0.30	0.21	0.48	Yes	No	No

HORIZONTAL SLIDER	Glass Type Exterior + Interior	Gap Fill	Grid Option	NFRC Performance Ratings			EnergyStar® v7 Climate Zone Compliance			
				U-F	SHGC	VT	Southern	S.Central	N.Central	
Standard	LoE-366 + Clear	Air	no Grid	0.32	0.23	0.54	Yes	No	No	
			with Grid	0.32	0.21	0.48	Yes	No	No	
			Argon	0.29	0.23	0.54	Yes	No	No	
IMPACT rated (Missile-D) Requires DSB + 6.9L glass	LoE-366 + Clear	Air	no Grid	0.34	0.23	0.53	No	No	No	
			with Grid	0.35	0.21	0.48	No	No	No	
			Argon	0.29	0.23	0.53	Yes	No	No	
			Argon	with Grid	0.30	0.21	0.48	Yes	No	No

PICTURE WINDOW	Glass Type Exterior + Interior	Gap Fill	Grid Option	NFRC Performance Ratings			EnergyStar® v7 Climate Zone Compliance			
				U-F	SHGC	VT	Southern	S.Central	N.Central	
Standard	LoE-366 + Clear	Air	no Grid	0.30	0.25	0.59	No	No	No	
			with Grid	0.30	0.23	0.53	Yes	No	No	
			Argon	0.26	0.25	0.59	No	No	No	
IMPACT rated (Missile-D) Requires 3/16" + 8.6L glass	LoE-366 + Clear	Air	no Grid	0.39	0.26	0.56	No	No	No	
			with Grid	0.43	0.24	0.51	No	No	No	
			Argon	0.33	0.26	0.56	No	No	No	
STC rated (STC = 30) requires DSB + 3/16" glass thickness	LoE-366 + Clear	Air	no Grid	0.30	0.25	0.58	No	No	No	
			with Grid	0.30	0.23	0.52	Yes	No	No	
			Argon	0.26	0.25	0.58	No	No	No	
			Argon	with Grid	0.26	0.23	0.52	Yes	Yes	No

Unless specified, the NFRC values & Energy Star compliance are for double glazed, SSB (3/32") glass thickness. For glass thicknesses above this, contact your sales representative for ratings information.

It is recommended not to mix LoE-360 with LoE-366 products within the same building structure since the inward and outward color/shade appearances are noticeably different.

Please visit [WestlakeRoyalWindows.com](http://WestlakeRoyalWindows.com) for more Energy Star options.

You may qualify for a tax credit when you replace your existing windows. For more information, go to [energystar.gov](http://energystar.gov)



**Westlake**  
Royal Window Solutions™

Krestmark® Collection  
**220 Series** – Replacement



The Vinyl Replacement Window 220 is offered with a LoE glass option. LoE high performance glass with argon gas allows light to filter in while keeping the sun's harmful rays out. In addition, this special glazing saves energy and reduces utility costs by keeping the cool air inside in the summer and the warm air inside in the winter.

Note: All picture windows, shapes and one-frame glass larger than 30 square feet will come with Tempered Glass as standard for safety reasons. All additional charges for Tempered Glass will automatically be applied.

- 3" main frame beveled exterior profile gives an outstanding, bold appearance.
- Tilt-in sash for easy cleaning.
- Block and tackle balance system for long-lasting, smooth, quiet operation.
- 3/4" LoE E66 Environsealed Windows™, environmentally friendly with warm-edge spacer reduces thermal loss. Type and look of warm-edge spacer may vary.
- Ventilation control for opening windows only 4".
- Metal-reinforced center bar for better structural performance and weather tightness.
- Multi-chambered design for structural integrity, superior thermal performance, maintenance-free, vinyl frame and sash extrusions.
- Argon-enhanced glass improves energy efficiency.
- The Replacement 220 is available with an integral nail fin.
- Tempered glass, rain glass, obscure glass.
- Factory mulls (combined units) with continuous head and sill.



### Krestmark® Collection

### 220 Series – Replacement

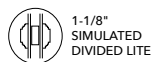
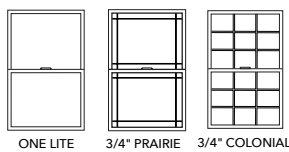

**CARDINAL IG**

#### NFRC PERFORMANCE RATINGS (3/4" overall IG with Quanex Duralite spacer)

SINGLE HUNG	Glass Type Exterior + Interior	Gap Fill	Grid Option	NFRC Performance Ratings			EnergyStar® v7 Climate Zone Compliance			
				U-F	SHGC	VT	Southern	S.Central	N.Central	
Standard	LoE-366 + Clear	Air	no Grid	0.33	0.22	0.51	No	No	No	
			with Grid	0.33	0.20	0.46	No	No	No	
			Argon	no Grid	0.30	0.22	0.51	Yes	No	No
			Argon	with Grid	0.30	0.20	0.46	Yes	No	No
STC rated (STC = 29) requires DSB + 3/16" glass thickness	LoE-366 + Clear	Air	no Grid	0.33	0.22	0.50	No	No	No	
			with Grid	0.33	0.20	0.45	No	No	No	
			Argon	no Grid	0.29	0.22	0.50	Yes	No	No
			Argon	with Grid	0.29	0.20	0.45	Yes	No	No

PICTURE WINDOW	Glass Type Exterior + Interior	Gap Fill	Grid Option	NFRC Performance Ratings			EnergyStar® v7 Climate Zone Compliance			
				U-F	SHGC	VT	Southern	S.Central	N.Central	
Standard	LoE-366 + Clear	Air	no Grid	0.32	0.23	0.54	Yes	No	No	
			with Grid	0.32	0.21	0.49	Yes	No	No	
			Argon	no Grid	0.28	0.23	0.54	Yes	Yes	No
			Argon	with Grid	0.28	0.21	0.49	Yes	Yes	No
STC rated (STC = 31) requires DSB + 3/16" glass thickness & 11/16" IG	LoE-366 + Clear	Air	no Grid	0.34	0.24	0.53	No	No	No	
			with Grid	0.36	0.22	0.48	No	No	No	
			Argon	no Grid	0.29	0.23	0.53	Yes	No	No
			Argon	with Grid	0.30	0.21	0.48	Yes	No	No

HORIZONTAL SLIDER	Glass Type Exterior + Interior	Gap Fill	Grid Option	NFRC Performance Ratings			EnergyStar® v7 Climate Zone Compliance			
				U-F	SHGC	VT	Southern	S.Central	N.Central	
Standard	LoE-366 + Clear	Air	no Grid	0.33	0.22	0.51	No	No	No	
			with Grid	0.33	0.20	0.46	No	No	No	
			Argon	no Grid	0.29	0.22	0.51	Yes	No	No
			Argon	with Grid	0.29	0.20	0.46	Yes	No	No
STC rated (STC = 29) requires DSB + 3/16" glass thickness & 11/16" IG	LoE-366 + Clear	Air	no Grid	0.34	0.22	0.51	No	No	No	
			with Grid	0.35	0.20	0.45	No	No	No	
			Argon	no Grid	0.29	0.22	0.51	Yes	No	No
			Argon	with Grid	0.30	0.20	0.45	Yes	No	No

Unless specified, the NFRC values & Energy Star compliance are for double glazed, SSB (3/32") glass thickness. For glass thicknesses above this, contact your sales representative for ratings information.

Please visit [WestlakeRoyalWindows.com](http://WestlakeRoyalWindows.com) for more Energy Star options.

You may qualify for a tax credit when you replace your existing windows. For more information, go to [energystar.gov](http://energystar.gov)









**Ply Gem**®  
WINDOWS & DOORS

## **BUILDER SERIES**

W I N D O W S



### **1100 SERIES SINGLE HUNG**

More value. More performance. More solutions. If you're looking for a window that delivers the best possible performance at the best possible value, look no further than Ply Gem Windows Builder Series. It's energy-efficient and offers a variety of material choices, most of which are virtually maintenance-free and can withstand the toughest tests, including the test of time. Plus, with our service and support you'll be able to get the job done the right way on time and on budget.



**1100 SERIES SINGLE HUNG**

plygem.com/windows



**COLOR OPTIONS:**



**PERFORMANCE:**

PERFORMANCE GRADE	
Overall Rating	Test Unit Size
LC - PG30	48" x 96"
R - PG40	36" x 96", 44" x 74"
R - PG45	36" x 74"
R - PG40	(Twin - 2) 79½" x 65½"
R - PG35	(Triple - 3) 107½" x 71½"

THERMAL PERFORMANCE				
R VALUE	3MM GLASS		NFRC CERTIFIED	
	U Factor	SHGC	VT	
<b>WITH WARM EDGE</b>				
¾" Low-E	2.86	0.35	0.31	0.55
¾" Low-E <sup>SC</sup>	2.86	0.35	0.23	0.43
¾" Low-E2+	3.33	0.3	0.3	0.53
¾" Low-E2+ <sup>SC</sup>	3.33	0.3	0.22	0.42
<b>WITH WARM EDGE+</b>				
¾" HP Glass	3.33	0.3	0.31	0.55
¾" HP <sup>SC</sup> Glass	3.33	0.3	0.22	0.43
¾" HP2+ Glass	3.85	0.26	0.3	0.53
¾" HP2+ <sup>SC</sup> Glass	3.85	0.26	0.22	0.42

All units are NAMI certified and rated in accordance with NFRC 100/200 standards by an AAMA accredited lab. Performance values reflect the performance of units tested with the following configuration: ¾" IGU, 3mm glass and no grilles.

R VALUE: Restrictive ambient air flow; U FACTOR: Rate of heat loss; SHGC: Solar Heat Gain Coefficient; VT: Visible Transmittance

NOTE: Colors shown are close approximations and may not be accurate representations for color matching. Please request color swatches from your Ply Gem sales representative to do so.

**STANDARD FEATURES**

- Energy-efficient Warm Edge insulating glass
- Maintenance-free multi-chamber PVC construction
- Fully fusion-welded corners on sash and frame for superior structural strength
- Dual lift rails on bottom sash for easy operation
- Integral nail fin (shown) for simple installation
- Bottom sash tilts in and is removable for easy cleaning
- Flush mounted tilt latches
- Traditional brick mould profile with 2¾" frame depth
- Interior glazed top sash, exterior glazed bottom sash
- Aluminum reinforced meeting rail with cam locks that engage keepers for your security
- Block and tackle balances

**OPTIONS**

**GLASS OPTIONS:**

Low-E, Low-E<sup>SC</sup>, Low-E2+, Low-E2+<sup>SC</sup>, HP, HP<sup>SC</sup>, HP2+, HP2+<sup>SC</sup>, Warm Edge+ spacer, rain, obscure and tempered

Can be ordered ENERGY STAR<sup>®</sup> version 7 certified in the South Central and Southern zones.

**GRILLE OPTIONS:**

Color-coordinated grilles-between-the-glass (BGB) in ⅝" and ¾" flat, 1⅜" SDL with Shadow Bar

**PRODUCT CONFIGURATIONS:**

Singles, twins, triples, fixed, combinations and a wide variety of architectural shapes

**HARDWARE OPTIONS:**

Safety vent latch to meet ASTM F2090 requirements, factory installed or prep for field installation

**SOUND CONTROL OPTIONS:**

STC 24, 27, 31, or 34



**4800 THERMAL BREAK ALUMINUM**

**BUILDER SERIES**

W I N D O W S



**4810 SINGLE HUNG**



**MORE VALUE. MORE PERFORMANCE. MORE SOLUTIONS.**

If you're looking for a window that delivers the best possible performance at the best possible value, look no further than Ply Gem Windows Builder Series. It's energy-efficient and offers a variety of material choices, most of which are virtually maintenance free and can withstand the toughest tests, including the test of time. Plus, with our service and support you'll be able to get the job done the right way on time and on budget.

[windows.plygem.com](http://windows.plygem.com)

# 4800 THERMAL BREAK ALUMINUM



## 4810 SERIES SINGLE HUNG



### STANDARD FEATURES

- Thermally broken aluminum frame with polyurethane poured in place and debridged to reduce thermal conductivity of aluminum frame
- Virtually maintenance-free extruded aluminum construction with electrostatically applied finish
- Sloped sill allows for proper water drainage to the exterior
- Sleek profile provides larger viewing area
- Interior glazing allows for easier glass replacement
- Side load removable bottom sash
- Block and tackle balance system
- Energy-efficient Warm Edge insulating glass
- Structural meeting rail provides rigid stability and allows for a tighter, weather-resistant unit
- Dual lift rails on bottom sash for easy operation
- Frame depth available in 2 7/16"
- Integral nailing fin with a 1 3/8" setback for simple installation



### 4810 SERIES THERMAL PERFORMANCE

	R Value	NFRC CERTIFIED		
		U Factor	SHGC	VT
<b>WARM EDGE</b>				
3/4" IGU Clear	1.61	0.62	0.65	0.67
3/4" IGU Low E	2.08	0.48	0.31	0.57
3/4" IGU Low E <sup>SC</sup>	2.13	0.47	0.24	0.44
3/4" IGU Low E 2+	2.33	0.43	0.30	0.55
3/4" IGU Low E <sup>SC</sup> 2+	2.33	0.43	0.23	0.43
3/4" IGU HP	2.27	0.44	0.31	0.57
3/4" IGU HP <sup>SC</sup>	2.27	0.44	0.24	0.44
3/4" IGU HP 2+	2.50	0.40	0.30	0.55
3/4" IGU HP <sup>SC</sup> 2+	2.50	0.40	0.23	0.43
<b>WARM EDGE</b>				
3/4" IGU Low E	2.13	0.47	0.31	0.57
3/4" IGU Low E <sup>SC</sup>	2.13	0.47	0.24	0.44
3/4" IGU Low E 2+	2.38	0.42	0.30	0.55
3/4" IGU Low E <sup>SC</sup> 2+	2.38	0.42	0.23	0.43
3/4" IGU HP	2.27	0.44	0.31	0.57
3/4" IGU HP <sup>SC</sup>	2.33	0.43	0.24	0.44
3/4" IGU HP 2+	2.50	0.40	0.30	0.55
3/4" IGU HP <sup>SC</sup> 2+	2.50	0.40	0.23	0.43

All units are NAMI certified and rated in accordance with NFRC 100/200 standards by an AAMA accredited lab. Performance values reflect the performance of units tested with the following configuration: 3/4" IGU, 3mm glass and no grilles.

R VALUE: Restrictive ambient air flow; U FACTOR: Rate of heat loss; SHGC: Solar Heat Gain Coefficient; VT: Visible Transmittance

### OPTIONS

#### GLASS OPTIONS:

Low-E, Low-E<sup>SC</sup>, Low-E2+, Low-E<sup>SC</sup>2+, HP, HP<sup>SC</sup>, HP2+, HP<sup>SC</sup>2+, obscure and tempered

#### GRILLE OPTIONS:

Color-coordinated grilles-between-the-glass (GBG) in 5/8", 3/4" flat and 1-3/16" SDL with shadow bar

#### PRODUCT CONFIGURATION:

Matching side lites, fixed panels, transoms, segmented transoms and a wide selection of architectural shapes

#### HARDWARE OPTION:

Safety vent latch to meet ASTM F2090-2008 requirements

#### COLOR OPTIONS:

WHITE

BRONZE

BLACK

NOTE: Colors shown are close approximations and may not be accurate representations for color matching. Please request color swatches from your Ply Gem sales representative to do so.



1. Low E glass options available including solar cooling glass for warm climates.
2. Optional HP glass combines Low-E with argon gas fill for high performance. HP options include solar cooling and inside surface Low-E options.
3. Impact Rated units are available in select sizes and configurations.







**BURRIS**  
WINDOWS

# BURRIS WINDOWS

## TECTVIEW EX VINYL



### TectView™ Ex

#### TectView Ex

##### Max Sizes:

- Single Hung (Shown)  
54" x 120"
- Double Hung  
48" x 84"
- Single Slider  
96" x 66"
- End Vent Slider  
120" x 66"
- Picture Window  
60" x 120"



#### STANDARD FEATURES

- 3 ¼" jamb depth
- Light Commercial rating and DP 50 available in Single Hung, Single Slider and Picture Window (Specify when ordering)
- Equal site lines on all operating windows
- Superior styling for the look of wood without the maintenance
- Integral J-channel for siding applications and superior frame strength
- Exterior glazing on all EX windows
- ¾" Caldwell adjustable stainless steel balance system

#### OPTIONS

- Sash Limiting Devices
- Can upgrade to 1" insulated glass units
- Full or half screens available on all windows
- Full screen track on picture windows for optional solar screens
- Laminated and triple pane glass available





# TectView™ Ac

### TectView Ac

#### Max Sizes:

Single Hung (Shown)

48" x 96"

Single Slider

72" x 60"

End Vent Slider

120" x 60"

Picture Window

60" x 84"



#### STANDARD FEATURES

- 2 7/8" jamb depth
- Operating or fixed extended round windows as narrow as 23 1/2" wide
- Fiberglass half screen on all operating windows standard
- 1/2" Caldwell adjustable stainless steel balance system
- Slimmer profile for more visible glass
- Equal site lines on all operating windows
- 2 locks on all windows wider than 23 1/4" wide
- Reinforced center bars

#### OPTIONS

- Sash Limiting Devices







## TectView™ Ca

### STANDARD FEATURES

- 3 ¼" jamb depth
- Casement, Fixed Casement and Awning utilize the same frame for equal glass in combination units and uniform appearance
- Truth Hardware and folding handles on all operable units
- Stainless steel hardware available for coastal applications



### STANDARD FEATURES

- Stainless steel mortice lock keepers
- 4 7/8" jamb depth
- Industry leading Amesbury Hardware
- Exterior Key lock standard
- Precision sealed bearings on rollers for a lifetime of smooth operation
- Aluminum roller track
- Color matched threshold
- Steel reinforcement in meeting rail, sash stile, and mortice lock frame side.
- DP50 in new construction and replacement up to 96" x 82" two panel doors.
- 3 panel door and sidelites available

## TectView™ Pd

### OPTIONS

- Impact resistant 2 panel door to 96" x 82" in new construction or replacement installation.
- 3 panel door available in XOO, OXO, AND OOX
- Transoms and sidelites available in matching frame



## PRODUCT DETAILS



*We can custom manufacture any kind of window you need, whether you want windows for a new construction project or to replace the windows in your existing home. Our offerings include single-hung, double-hung, slider, casement, picture and geometric shapes.*

### Replacements

Our Replacement windows are made in  $\frac{1}{8}$ " increments to ensure a more custom fit for the homeowner. In the end, we'll make sure your windows fit precisely and securely, so you can be absolutely confident in your Burris windows.

### Window Styles Options

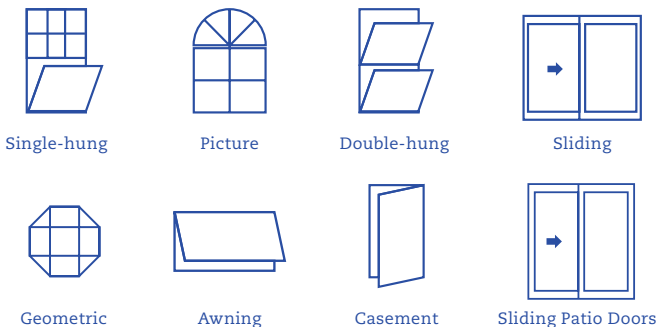

### Obscure Glass Options

Burris Windows offers many different styles of obscure glass, which can be used to decoratively separate spaces, yet allow light to pass through. Whether you are trying to decorate an office or conference room door, front door of your home, or an exterior bathroom window we have the right obscure glass for you.

Divided lite options between the glass – standard  $\frac{5}{8}$ " wide flat grid, 1" wide contour grids.  $1 \frac{1}{8}$ " wide simulated divided lites are available on the exterior of the glass.

### Quality is Standard

#### ALL OUR WINDOWS COME STANDARD WITH:

- Double strength glass, Cardinal Lowe 270 and Argon. We also offer Cardinal Lowe 366, for more information on our glass see our website or go to: [www.cardinalcorp.com](http://www.cardinalcorp.com).
- Factory or Field mullions available on all windows and doors.
- Industry Leading Caldwell Stainless Steel Adjustable Constant force balance system on all single and double hungs.
- Extruded interlock in sash and meeting rail of all single hung, double hung and sliding windows.
- Aluminum reinforced meeting rail and lock rail in all single hung, double hung and sliders.

### Colors

All Burris windows and doors available in the three colors white, tan and clay with color-matched hardware.



### Efficiency

All Burris Windows can be ordered to meet ENERGY STAR® requirements in all 50 states.



# WINDOR SYSTEMS

2750 FOLDING WINDOW



# WINDOR® SYSTEMS

*For the Name and the Products You Should Trust!*





### 2750 Bi-Folding Window System



#### Features and Benefits

- Vinyl Frame with aluminum reinforcement
- Foam backed seal on main frame
- Contemporary style vinyl sash
- Welded sash corners
- Dual interlocking weather seal on sash for superior air and thermal performance
- Centor™ E3 hardware system in stainless and dark powder coat finishes
- Stainless multipoint locking hardware
- Internal Multipoint shoot bolt system

#### Glass Options

- Cardinal™ 366® LoE Dual Glaze tempered with warm edge spacer system
- Clear, obscure, and custom glass is available

#### Hardware

- Hardware Colors; White, Black powder coat, and Brushed Chrome

#### Grids

- SDL (Simulated Divided Lite)
- Flat (Colonial)
- Sculptured (Continental)

#### Sizes

- New Construction / Replacement Custom applications



Drawings show out-swing operation

AVAILABLE THROUGH



Win-Dor is a proud member of the following



[www.windorsystems.com](http://www.windorsystems.com)







**SIMONTON**<sup>®</sup>  
WINDOWS & DOORS

# StormBreaker Plus®

PREMIUM VINYL COASTAL WINDOWS



IMPACT ZONE CERTIFIED  
MISSILE D & HVHZ



**IMPRESSIVE INSIDE & OUT**





## Tested and Certified for Coastal Living.



HVHZ Certified

### HVHZ CERTIFIED

Select window and patio door sizes are certified for High-Velocity Hurricane Zones (HVHZ), meeting the highest impact standards set by the Florida Building Commission for Miami-Dade and Broward County.



Missile D Certified

### MISSILE D CERTIFIED

Meets Missile D impact specifications for the Florida Building Commission and the Texas Department of Insurance evaluation for the Texas Coast.



SCAN TO SEE SIMONTON IMPACT TESTING THAT SUBJECTS OUR WINDOWS AND PATIO DOORS TO SEVERE HURRICANE CONDITIONS.



\* StormBreaker Plus windows and patio doors have SafePoint Max or Max+ impact-resistant glass required for your certification level, style and product size.





## The Strength is in the Design.

Simonton StormBreaker Plus® windows deliver the coastal performance your home requires, along with essential features that enhance your home's comfort, aesthetics and convenience.

### **SIMONTON STORMBREAKER PLUS** DOUBLE HUNG

#### **1. BUILT-IN STRENGTH**

Fusion-welded frame and sash increase weather resistance and durability, while the reinforced profiles add to the window's structural integrity.

#### **2. BEAUTIFUL DESIGN**

Timeless beveled frame design complements any home.

#### **3. STORM PROTECTION**

SafePoint® Max impact-resistant laminated glass protects against high winds and windborne debris.\*

#### **4. ENERGY EFFICIENT**

1" insulating glass unit with ProSolar® Low-E glass and Argon gas increases efficiency and comfort.

#### **5. LONG-LASTING BEAUTY**

The vinyl color is molded throughout the profile for long-lasting beauty that withstands coastal conditions that won't rot, deteriorate, pit or peel like wood or aluminum windows.

#### **6. WATER BARRIER**

Triple-stepped, sloped Simonton Sill® and Lap Lok® meeting rail on Double Hung windows protect against wind and rain.

#### **7. TROUBLE-FREE OPERATION**

The stainless-steel constant force coil spring balance system easily raises and lowers the sash.



\* StormBreaker Plus windows have SafePoint Max or Max+ impact-resistant glass required for certification level and product size.

# Select Your Design Options.

Bring your vision to life with a variety of colors and hardware options to complete the aesthetic of your home. StormBreaker Plus® windows and doors are built with virtually maintenance-free vinyl that provides long-lasting beauty and withstands harsh coastal conditions.

## INTERIOR/EXTERIOR VINYL COLORS



White



Tan

## CUSTOM EXTERIOR FINISHES



Bronze

## HARDWARE FINISHES



White



White



Tan



Tan



Brass



Brass



Dark Bronze  
(Patio Door only)

Due to limitations in the printing process, actual colors may vary from printed materials. Please see a sample of the product before making your final color selection.



# Sunroom

WELCOME TO YOUR NEW FAVORITE ROOM.



## WHY SIMONTON WINDOWS FOR YOUR SUNROOM?

- A sunroom built with Simonton windows offers a quiet, comfortable, energy-efficient haven you can use year-round.
- Simonton windows are remarkably durable and they're more affordable than acrylic.
- Simonton windows are easy to install in 2," 3" or 4" aluminum frames.
- Ordinary glass cleaner is all it takes to keep Simonton windows crystal clear.

**Sunroom**



**A ROOM IS BORN.**

Transform your porch, patio or other outdoor living space into an inviting, sun-filled room that you'll enjoy all year long. Simonton windows are the perfect choice for a sunroom that provides maximum enjoyment season after season. A generous selection of styles and sizes allows you to choose the windows that will complement your home beautifully.

**Contact your Simonton representative to learn more.**



**Simonton ProFinish® Contractor Series**

- **Premium vinyl construction** is virtually maintenance-free.
- A sleek, 2 7/8" **narrow frame** provides an attractive, streamlined appearance.
- An exclusive **Lap-Lok® meeting rail** overlaps and interlocks the sash to virtually eliminate air and water infiltration.
- The **extruded lift rail** is easy to grasp and remarkably durable.
- The **sloped sill design** forces water away from the window quickly.
- A **20-year Limited Warranty** covers screens, hardware and glass. Vinyl is covered by a **Lifetime Limited Warranty**.
- **Easy to install** in 2" or 3" aluminum frames.



**ProSolar®** Low E glass with an Argon gas fill provides great energy efficiency while helping to retain cooled air in warmer months.

**Styles**

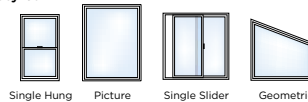

**Simonton Reflections® 5500 Series**

- **Premium vinyl construction** requires virtually no maintenance.
- A classic 3 1/4" frame is as **durable** as it is beautiful.
- An exclusive **Lap-Lok® meeting rail** overlaps and interlocks the sash to virtually eliminate air and water infiltration.
- The **extruded pull stile** is easy to grasp and won't loosen or break off over time.
- A **Double Lifetime Limited Warranty** includes vinyl, hardware, screens and glass.
- **Easy to install** in 3" or 4" aluminum frames.



Our most advanced Low E glass, optional **ProSolar® Shade** is a spectrally selective glass that blocks damaging UV rays while allowing desirable light into the home. The unique formula with three layers of silver helps provide solar heat control, fade protection, visibility and energy savings.



**Styles**

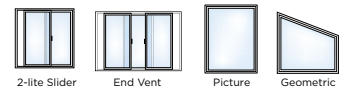

**SIMONTON HAS TAKEN THE GUESSWORK OUT OF GLASS.**



Order Simonton's regionally specific ENERGY STAR® glass packages to meet the guidelines for the Southern and South-Central regions.



**ENERGY STAR Regions**

- South-Central
- Southern





**VELUX®**



Solar Powered Fresh Air Skylight

VCS Model



## Solar Powered Fresh Air Skylight

### VCS Model

The VELUX Solar Powered Fresh Air Skylight uses the power of the sun to refresh your home with the touch of a button.

- Solar-powered battery control system easily opens and closes skylight with remote or smartphone app
- Rain sensor automatically closes skylight at the first sign of rain
- Safety Glass standard on all VCS models



### More Information

Standard Sizes	2222	2234	2246	3030	3046	3434	3737	4622	4630	4646
 0° - 60° 0:12 - 20:12										
Outside Curb (W-in. x H-in.)	25 ½ x 25 ½	25 ½ x 37 ½	25 ½ x 49 ½	33 ½ x 33 ½	33 ½ x 49 ½	37 ½ x 37 ½	40 ½ x 40 ½	49 ½ x 25 ½	49 ½ x 33 ½	49 ½ x 49 ½



Add a pre-installed solar-powered shade



Smartphone control and automation available





Electric Fresh Air Skylight

VCE Model

## Electric Fresh Air Skylight

### VCE Model

The ideal daylighting solution for abundant natural light and fresh air at the touch of a button.

- Concealed motor and control system easily opens and closes skylight with a remote
- Rain sensor automatically closes skylight at the first sign of rain
- Compatible with VELUX skylight shades for ultimate light control
- Safety Glass is standard on all VCE models



**More Information**

Standard Sizes	2222	2234	2246	3030	3046	3434	4646
Outside Curb (W-in. x H-in.)	25 ½ x 25 ½	25 ½ x 37 ½	25 ½ x 49 ½	33 ½ x 33 ½	33 ½ x 49 ½	37 ½ x 37 ½	49 ½ x 49 ½



Add a pre-installed solar-powered shade



Smartphone control and automation available



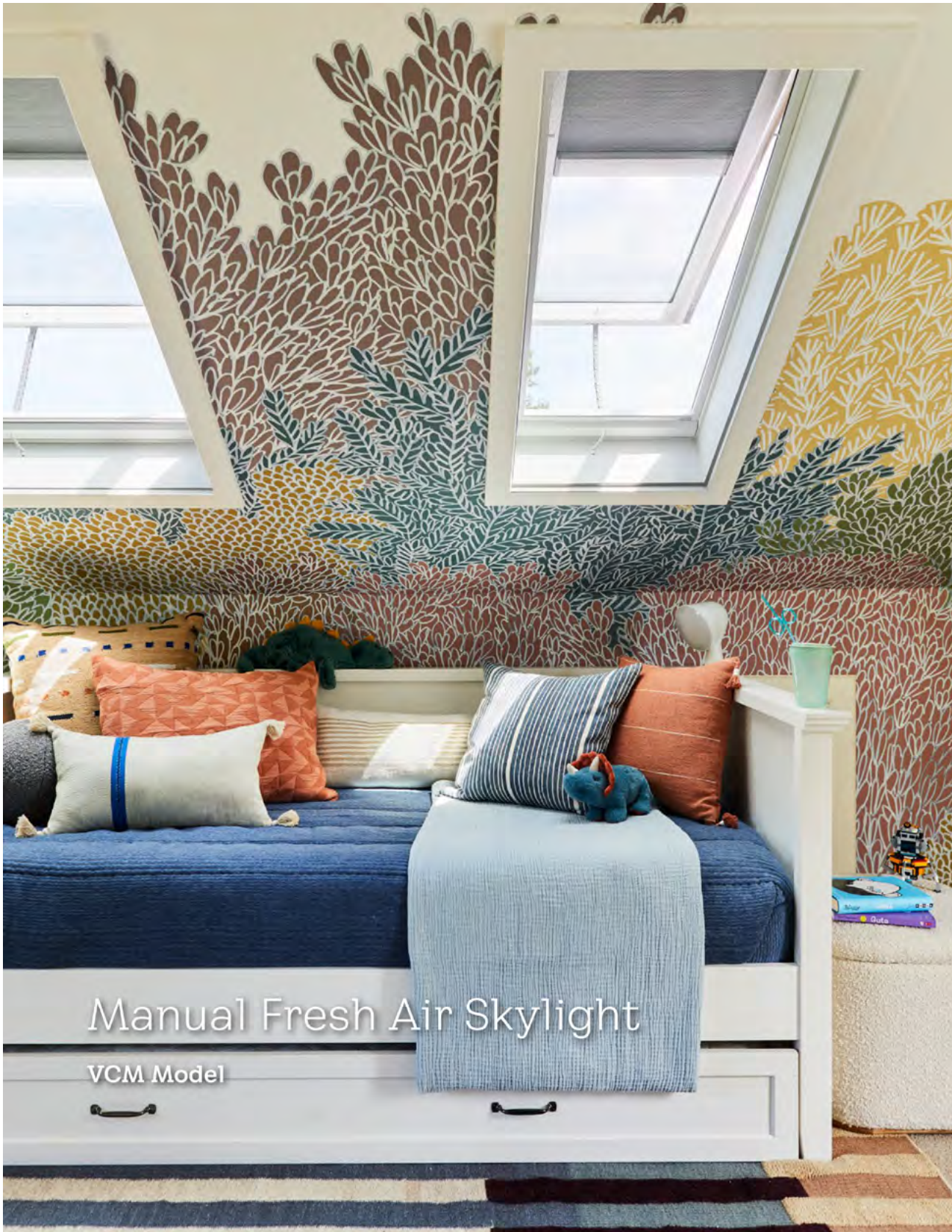

Manual Fresh Air Skylight

VCM Model

## Manual Fresh Air Skylight

### VCM Model

Create a healthier home with just the right balance of daylight and fresh air.

- Manually open and close the skylight with smooth-turning handles or control rods
- White frames and sashes create a sleek, high quality finish
- Safety Glass is standard on all VCM models



[More Information](#)

Standard Sizes	2222	2234	2246	3030	3046	3434	4646
 0° - 60° 0:12 - 20:12							
Outside Curb (W-in. x H-in.)	25 ½ x 25 ½	25 ½ x 37 ½	25 ½ x 49 ½	33 ½ x 33 ½	33 ½ x 49 ½	37 ½ x 37 ½	49 ½ x 49 ½



Add a pre-installed solar-powered shade



Smartphone control and automation available





HGTV  
**URBAN  
OASIS**  
— 2019 —  
PROUD SPONSOR

# Fixed Skylight

## FCM Model

Visually expand your space and transform your home with natural light and sky views.

- Low profile creates a clean, streamlined appearance on the roof
- Twice the natural light as vertical windows
- Safety Glass is standard on all FCM models



**More Information**

Standard Sizes	1430	1446	2222	2230	2234	2246	2270
Outside Curb (W-in. x H-in.)	17 ½ x 33 ½	17 ½ x 49 ½	25 ½ x 25 ½	25 ½ x 33 ½	25 ½ x 37 ½	25 ½ x 49 ½	25 ½ x 73 ½

Standard Sizes	3030	3046	3055	3434	3446	4646	4672
Outside Curb (W-in. x H-in.)	33 ½ x 33 ½	33 ½ x 49 ½	33 ½ x 58 ½	37 ½ x 37 ½	37 ½ x 49 ½	49 ½ x 49 ½	49 ½ x 75 ½



Add a pre-installed solar-powered shade



Smartphone control and automation available



# Simple control of all VELUX skylights and shades with one remote.



The Touch remote controls both skylights and shades, featuring ventilation timing and programmable presets.

We believe it should be easier to create your perfect home environment with VELUX skylights and shades. Now, with VELUX Touch, you only need to reach for one remote to take control of every skylight and shade you install. Talk about indoor comfort right at your fingertips!

- Remote operation in room where your skylights are installed
- Operate multiple products at once
- Group skylights and shades to operate together
- Set the ventilation timer for regular automated home airing
- Lock home option to securely close all your skylights automatically
- Preset shade and skylight positions for even easier operation

**More Information**





## Remote Comparison



### VELUX Wall Switch

For customers that want basic and simple benefits, and no smartphone control.

### VELUX Touch

### VELUX App Control

For customers that wish for more benefits and smartphone control, without full automation of products.

### VELUX ACTIVE

For customers that wish to see insight into air and temperature statistics of their home and improve it through automatic ventilation and heat control.

Price	Included with Product	\$	\$	\$\$
Remote Operation Inside the Room	✓	✓	✓	✓
Remote Operation from Anywhere			✓	✓
Operation of Multiple Products		✓	✓	✓
Requires Wi-Fi Connection			✓	✓
Compatible with Apple HomeKit® and Google Assistant™			✓	✓
Group Products		✓	✓	✓
Ventilation Timer		✓	✓	✓
Lock Home Option (close all skylights)		✓	✓	✓
Accessible to All Household Members	✓	✓	✓	✓
Scheduling to Personal Preferences			✓	✓
Voice Control			✓	✓
Sensor-based Automation				✓
Use of Weather Data				✓
Live Indoor Sensor Data				✓





## Three Layers of Water Protection

At VELUX, we've developed three layers of water protection to safeguard your house against damaging leaks. The VELUX Skylight System carries a 10-year installation warranty, plus 20 years on glass, 10 years on product, and 5 years on shades and controls.

Rest easily underneath your skylight knowing that it will never let in rain or moisture.



- 1 **Pre-attached Gasket** provides a tight outer seal for leak-proof installation.
- 2 **Adhesive Underlayment** provides secondary water protection in harsh weather conditions.
- 3 **Engineered Flashing** provides primary water protection and allows for easy installation.

# Complete light control.

## Solar-Powered Shade Pairing

VELUX shades allow you to control the light, enhance your decor, and improve energy efficiency.

We offer the option of ordering VELUX Solar Powered Fresh Air Skylights with **Pre-Installed White Room Darkening, Double-Pleated shades.**

- Room darkening, double-pleated shade
- Blackout cloth, honeycomb structure
- Neat pleats

**In-Stock Shade<sup>1</sup>** Free factory installation  
Room-Darkening Double-Pleated



White

[More Information](#)

**Special Order<sup>2</sup>** Ships separately from skylight  
Room-Darkening Double-Pleated



Light-Filtering Single-Pleated



<sup>1</sup> **In-Stock:** Available for factory installation, 2-4 business days. Custom sizes must be placed as special order. <sup>2</sup> **Special Order:** Not available for factory installation. Shades ship separately from your skylight, 14 business days.

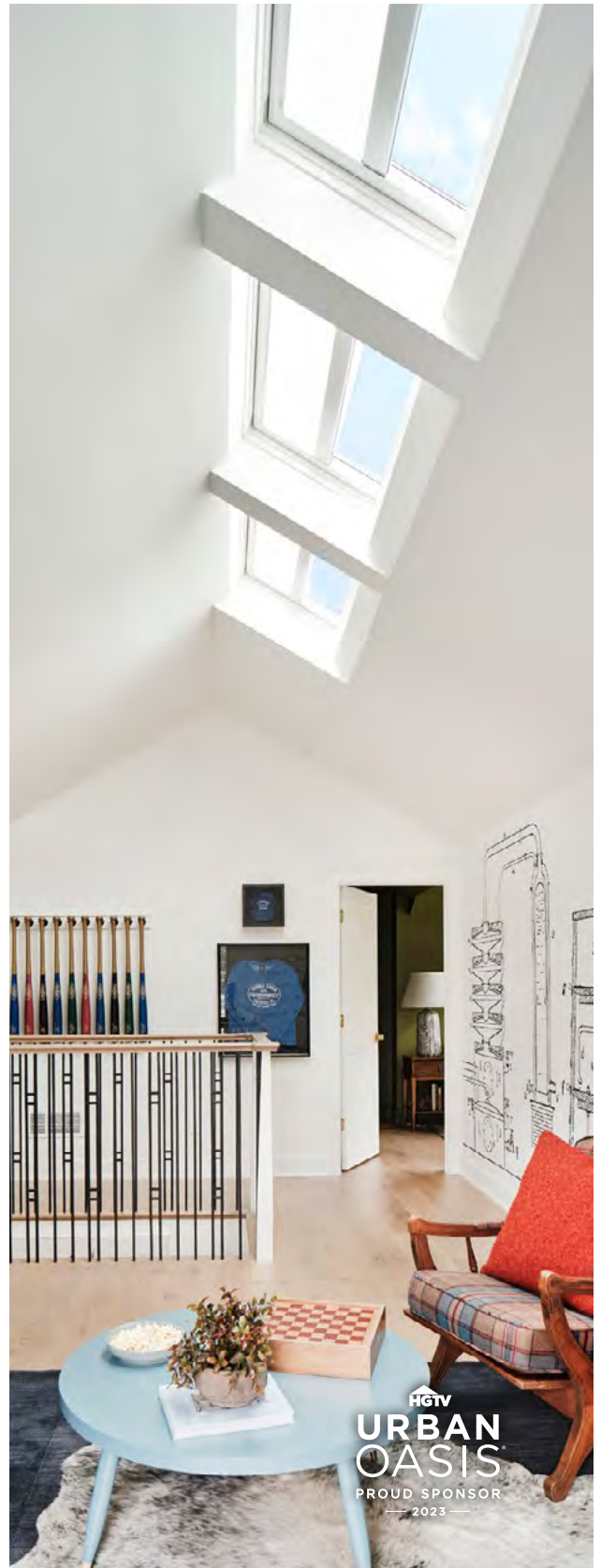

HGTV  
**URBAN OASIS**  
PROUD SPONSOR  
— 2023 —

QPF

# Self-Flashed Fixed Skylight

The VELUX Fixed Self-Flashed Skylight is a daylighting alternative to skylights with traditional flashing methods. This skylight features a pre-installed metal self-flashing to provide a leak-free installation and designed to be used on thin roofing materials. Additionally, with its clean exterior profile, this skylight provides uninhibited bright natural light to the space below.

**Ideal Applications:**  
 Out of reach **entry ways**, **living rooms** and **bedrooms** that can benefit from daylight.

Eligible for a  
**Federal Solar Tax Credit**  
 off product and installation



**FEATURES & BENEFITS**

- Clean exterior profile provides natural light without obstructing roofline
- Versatile sizing allows for greater flexibility in positioning options
- Seamlessly pairs with any VELUX shades for optimal light control — select shades can be pre-installed for free
- Eligible for Federal Solar Tax Credit\* with the addition of Solar Shades

**PRODUCT DETAILS**

- **Laminated LoE3 Glass:** double-paned argon-gas-filled LoE3 glass that provides excellent energy performance for year round comfort. Plus, it includes the added safety of laminated glass, which building codes require for out-of-reach applications.
- Pre-finished white painted frames
- 10 year hail with Clean, Quiet & Safe glass

**OPTIONAL SKYLIGHT UPGRADES**

- Impact Glass
- White Laminated Glass
- Tempered LoE

**ACCESSORIES**

- Factory pre-installed Room-Darkening or Light Filtering shades



[veluxusa.com](http://veluxusa.com)  
 \*For more information visit [veluxusa.com/taxcredit](http://veluxusa.com/taxcredit)

V5065-0921  
 ©2021 VELUX Group. \*VELUX, VELUX logo are registered trademarks.

## QPF

# Self-Flashed Fixed Skylight

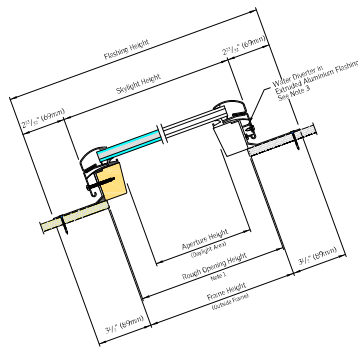

VERTICAL CROSS SECTION

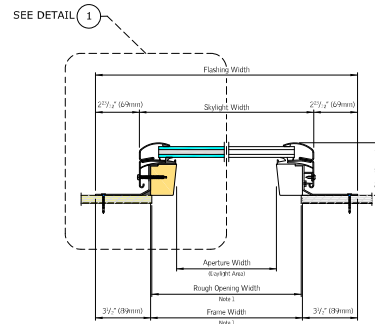

HORIZONTAL CROSS SECTION

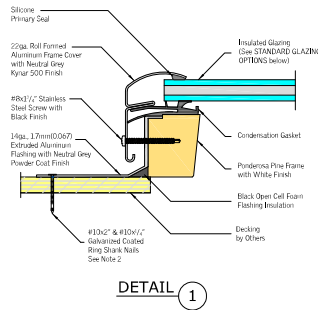

DETAIL 1

### COMPLIANCE AND CERTIFICATIONS

- DBPR Florida
- IAPMO
- NFRC, National Fenestration Rating Council
- WDMA, Window & Door Manufacturing Association

		2222	2230	2246	3030	3046	4646
Rough Opening Width	(W-in.)	22 1/2	22 1/2	22 1/2	30 1/2	30 1/2	46 1/2
	(H-in.)	22 1/2	30 1/2	46 1/2	30 1/2	46 1/2	46 1/2
Daylight Area	(Sq. Feet)	2.63	3.71	5.87	5.24	8.29	13.12

[veluxusa.com](http://veluxusa.com)  
 \*For more information visit [veluxusa.com/taxcredit](http://veluxusa.com/taxcredit)

V5065-0921  
 ©2021 VELUX Group. ®VELUX, VELUX logo are registered trademarks.



## FX Double Dome Skylight Technical Product Data Sheet

**Description**

- FX Fixed Curb Mount Double Dome Skylight that mounts to a site-built curb (residential curbs typically 2x4 or 2x6). Fixed skylight, provided with various acrylic glazings, is manufactured with a mill finish aluminum frame. Integral inner frame/gasket prevents air and water infiltration while allowing the removal of interior condensation.

**Installation**

- No designated top, bottom, or sides for installation in any direction.
- Mill finish exterior frame.
- Encapsulated inner frame is 100% thermally broken.
- 0 degrees to 60 degrees, use standard installation procedure.

**Interior Accessories**

- None

**Standard Sizes**

- 2222, 2246, 3030, 3434, 4646

**Special Sizes**

- Custom sizes with widths from 17" to 102" and heights from 17" to 150"

**Glazings**

Acrylic white over clear	0A2A1
--------------------------	-------

Size	Inside Curb	Outside Curb	Max Skylight Clearance
2222	22-1/2" x 22-1/2"	25-1/2" x 25-1/2"	26-11/16" x 26-11/16"
2246	22-1/2" x 46-1/2"	25-1/2" x 49-1/2"	26-11/16" x 50-11/16"
3030	30-1/2" x 30-1/2"	33-1/2" x 33-1/2"	34-11/16" x 34-11/16"
3434	34-1/2" x 34-1/2"	37-1/2" x 37-1/2"	38-11/16" x 38-11/16"
4646	46-1/2" x 46-1/2"	49-1/2" x 49-1/2"	50-11/16" x 50-11/16"

Custom Sizes (OC)	Width	17" to 102"
	Height	17" to 150"

Minimum OC 17"w x 17"H



**Warranty**

- **Skylight** – 5 years from the date of purchase; VELUX warrants that the skylight will be free from defects in material and workmanship.

**Flashings**

- ECL - Engineered flashing for single installation with thin roofing material (1/2" max) for roof pitch from 10-60 degrees.
- ECW - Engineered flashing for single installation with tile roofing material (over 3/4") for roof pitch from 14-60 degrees.

Consult with Customer Service for special glazing options.

## QX Double Dome Skylight Technical Product Data Sheet

### Description

- QX pan flashed Double Dome Skylight that mounts to a residential roof deck. Fixed skylight, provided with acrylic glazings, is manufactured with a mill finish aluminum frame. Integral inner frame/gasket prevents air and water infiltration while allowing the removal of interior condensation.

### Installation

- No designated top, bottom, or sides for installation in any direction.
- Mill finish exterior frame.
- Encapsulated inner frame is 100% thermally broken.
- 10 degrees to 60 degrees, use standard installation procedure.

### Flashings

- N/A

### Interior Accessories

- None

### Type Sign

- Example QX 2222 0A2A1 01BM05
- Tag on exterior frame.

### Standard Sizes

- 2222, 2246

### Special Sizes

- No custom sizes

### Glazings

Acrylic white over clear	0A2A1
--------------------------	-------



### Warranty

- **Skylight** – 5 years from the date of purchase; VELUX warrants that the skylight will be free from defects in material and workmanship.

Size	Rough Opening	Outside Flashing
2222	22-1/2" x 22-1/2"	28-5/8" x 28-5/8"
2246	22-1/2" x 46-1/2"	28-5/8" x 52-5/8"

Consult with Customer Service for special glazing options.



MM090224WC